



# Grid-connected PV Inverter

SUN-60K-G

SUN-70K-G

SUN-75K-G

SUN-80K-G

## User Manual

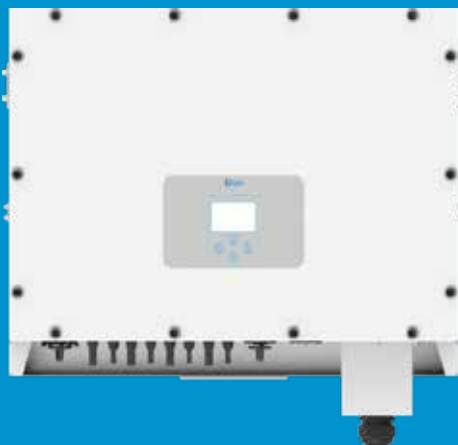

# Contents

<b>1. Introduction</b>	- 1 -
1.1 Appearance Introduction	- 1 -
1.2 Labels description	- 1 -
1.3 Parts list	- 2 -
1.4 Product handling requirements	- 3 -
<b>2. Safety warnings and instructions</b>	- 3 -
2.1 Safety signs	- 3 -
2.2 Safety instructions	- 4 -
2.3 Notes for using	- 4 -
<b>3. Operation Interface</b>	- 5 -
3.1 Interface View	- 5 -
3.2 Status Indicator	- 5 -
3.3 Buttons	- 6 -
3.4 LCD Display	- 6 -
<b>4. Product installation</b>	- 7 -
4.1 Select installation location	- 7 -
4.2 Mounting bracket of inverter	- 9 -
4.3 Installations Tools	- 10 -
4.4 Inverter Installation	- 10 -
<b>5. Electrical Connection</b>	- 11 -
5.1 DC input terminal connection	- 11 -
5.2 AC input terminal connection	- 13 -
5.3 The connection of the ground line	- 16 -
5.4 Inverter monitoring connection	- 17 -
<b>6. Startup and Shutdown</b>	- 18 -
6.1 Start up the inverter	- 18 -
6.2 Inverter Shutdown	- 18 -
6.3 Anti-PID Function(optional)	- 19 -

- 7. Zero-export function via energy meter** ..... - 19 -
  - 7.1 Multiple strings and parallel connection meters ..... - 29 -
  - 7.2 How to browse the load power of your PV grid-tieplant on monitoring platform? - 39 -
- 8. General Operation** ..... - 41 -
  - 8.1 The initial interface ..... - 44 -
  - 8.2 Statistics information ..... - 46 -
  - 8.3 Fault Record ..... - 48 -
  - 8.4 ON/OFF setting ..... - 49 -
  - 8.5 Parameter setting ..... - 50 -
- 9. Repair and Maintenance** ..... - 56 -
- 10. Error information and processing**..... - 56 -
  - 10.1 Error code ..... - 56 -
- 11. Specification** ..... - 61 -
- 12. EU Declaration of Conformity** ..... - 62 -

## About This Manual

The manual mainly describes the product information, guidelines for installation, operation and maintenance. The manual cannot include complete information about the photovoltaic (PV) system.

## How to Use This Manual

Read the manual and other related documents before performing any operation on the inverter. Documents must be stored carefully and be available at all times. **Contents may be periodically updated or revised due to product development. The information in this manual is subject to change without notice.** The latest manual can be acquired via [service@deye.com.cn](mailto:service@deye.com.cn)

## 1. Introduction

### 1.1 Appearance Introduction

On-grid inverter can convert solar panel DC power into AC power which can directly input to the grid. Its appearance is shown below. These models contain SUN-60K-G, SUN-70K-G, SUN-75K-G, SUN-80K-G.

The following is collectively referred to as “inverter” .

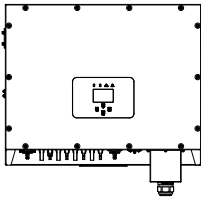



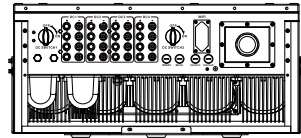

Pic 1.1 Front view









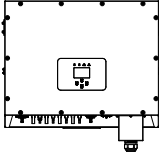
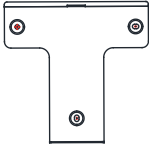

Pic 1.2 Bottom view

### 1.2 Labels description

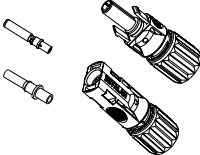
Label	Description
	Caution, risk of electric shock symbol indicates important safety instructions, which if not correctly followed, could result in electric shock.
	The DC input terminals of the inverter must not be grounded.
	CE mark of conformity
	Please read the instructions carefully before use.
	Symbol for the marking of electrical and electronics devices according to Directive 2002/96/EC. Indicates that the device, accessories and the packaging must not be disposed as unsorted municipal waste and must be collected separately at the end of the usage. Please follow Local Ordinances or Regulations for disposal or contact an authorized representative of the manufacturer for information concerning the decommissioning of equipment.

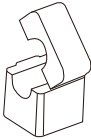
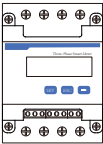
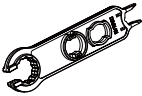
## 1.2 Parts list

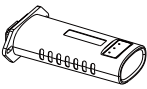
Please check the following table, to see whether all the parts are included in the package:

 <p>Grid-tied PV String Inverter x 1</p>	 <p>Wall mounting bracket x 1</p>	 <p>Mounting stainless steel screws M4×12 x 10</p>	
 <p>Wrench x 1</p>	 <p>DC+/DC- Plug connectors including metal terminal x N pairs</p>	 <p>Stainless steel anti-collision bolt M12×60 x 3</p>	
 <p>*Sensor Clamp(optional) x 3</p>	 <p>Meter(optional) x 1</p>	 <p>Solar Photovoltaic Connector Special Spanner x1</p>	 <p>HJA4 Core Wire Female Connector - Screw Crimp x1</p>
 <p>Datalogger (optional) x1</p>	 <p>Installation screws M5× 12 x 2</p>	 <p>User manual User manual x1</p>	

## 1.4 Product handling requirements

Lift the inverter out of the packing box and transport it to designated installation location.

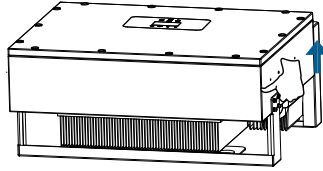

transport



### CAUTION:

Improper handling may cause personal injury!

- Arrange an appropriate number of personnel to carry the inverter according to its weight, and installation personnel should wear protective equipment such as anti-impact shoes and gloves.
- Placing the inverter directly on a hard ground may cause damage to its metal enclosure. Protective materials such as sponge pad or foam cushion should be placed underneath the inverter.
- Move the inverter by one or two people or by using a proper transport tool.
- Move the inverter by holding the handles on it. Do not move the inverter by holding the terminals.

## 2. Safety warnings and instructions

Improper use may result in potential electric shock hazards or burns. This manual contains important instructions that should be followed during installation and maintenance. Please read these instructions carefully before use and keep them for future reference.

### 2.1 Safety signs

Safety symbols used in this manual, which highlight potential safety risks and important safety information, are listed as follows:



### Warning:

Warning symbol indicates important safety instructions, which if not correctly followed, could result in serious injury or death.



### Shock Hazard:

Caution, risk of electric shock symbol indicates important safety instructions, which if not correctly followed, could result in electric shock.



### Safety Hint:

Note symbol indicates important safety instructions, which if not correctly followed, could result in some damage or the destruction of the inverter.



### High Temperature Hazard:

Caution, hot surface symbol indicates safety instructions, which if not correctly followed, could result in burns.

## 2.2 Safety instructions



### Warning:

Electrical installation of the inverter must conform to the safety operation rules of the country or local area.



### Warning:

Inverter adopts non-isolated topology structure, hence must insure DC input and AC output are electrical isolated before operating the inverter.



### Shock Hazard:

Prohibit disassembling inverter case, there existing shock hazard, which may cause serious injury or death, please ask qualified person to repair.



### Shock Hazard:

When PV module is exposed to sunlight, the output will generate DC voltage. Prohibit touching to avoid shock hazard.



5min

### Shock Hazard:

While disconnect the input and output of the inverter for maintenance, please waits for at least 5 mins until the inverter discharge the remnant electricity.



### High Temperature Hazard:

Local temperature of inverter may exceed 80°C while under operating. Please do not touch the inverter case.

## 2.3 Notes for using

The three phase string power inverter is designed and tested under related safety regulations. It can ensure the personal safety of the user. But as a electric device, it may cause shock or injury by incorrect operation. Please operate the unit under below requirements:

1. Inverter should be installed and maintained by qualified person under local standard regulations.
2. Must disconnect the AC side first, then disconnect DC side while doing installation and maintenance, after that, please wait at least 5 mins to avoid getting shocked.
3. Local temperature of the inverter may exceed 80 °C while under operating. Do not touch to avoid getting injured.
4. All electrical installation must be in accord with local electrical standards, and after obtaining the permission of the local power supply department, the professionals can connect the inverter to the grid.
5. Please take appropriate anti-static measure.
6. Please install where children can not touch.
7. The steps to start the inverter: 1) switch on the AC side circuit breaker, 2) Switch on the DC side circuit breaker of the PV panel. 3) Turn on the DC switch of the inverter.  
The steps to stop the inverter: 1) switch off the AC side circuit breaker, 2) switch off the DC side circuit breaker of the PV panel. 3) Turn off the DC switch of the inverter.
8. Don't insert or remove AC and DC terminals when the inverter is in normal operation.
9. The DC input voltage of the inverter must not exceed the maximum value of the model.

### 3. Operation Interface

#### 3.1 Interface View

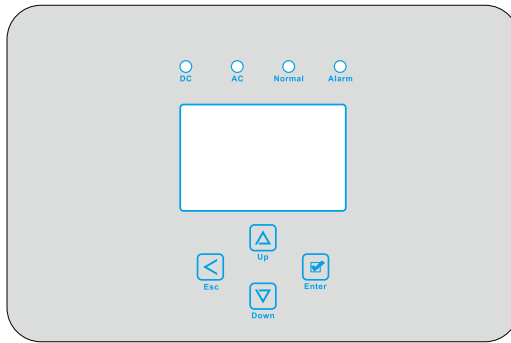

Pic 3.1 Front panel display

#### 3.2 Status Indicator

The inverter panel has 4 indicators, the left one is dc output indicators, green indicates normal DC input. Beside is the AC indicator, green indicating normal ac connection. Beside the AC indicator is the operating indicator, green indicating normal output. The right indicator is alarm. red indicates alarming.

Indicator	status	Explanation
● DC	on	Inverter detects DC input
	off	Low DC input voltage
● AC	on	Grid Connected
	off	Grid Unavailable
● NORMAL	on	Under normal operating
	off	Stop operating
● ALARM	on	Detected faults or report faults
	off	Under normal operating

Table 3.1 Status indicator lights



---

### 3.3 Buttons

There are four buttons on the inverter panel: Above is Up and increase button(UP), Below is down and decrease button(DOWN), Left is ESC button(ESC), Right is Enter button(ENTER). Achieving below functions by the four buttons:

- Page turning (use UP and DOWN button)
- Modify adjustable parameters (use ESC and ENTER button)

### 3.4 LCD Display

Three phase string inverter use 256\*128 dot formation display, Display below content:

- Inverter operation status and information;
- Operating information;
- Warning message and malfunction display.

## 4. Product installation

### 4.1 Select installation location

To select a location for the inverter, the following criteria should be considered:

WARNING: Risk of fire

- Do not install the inverter in areas containing highly flammable materials or gases.
- Do not install the inverter in potentially explosive atmospheres.
- Do not install in small closed spaces where air can not circulate freely. To avoid overheating, always make sure the flow of air around the inverter is not blocked.
- Exposure to direct sunlight will increase the operational temperature of the inverter and may cause output power limiting. It is recommended that inverter installed to avoid direct sunlight or raining.
- To avoid overheating ambient air temperature must be considered when choosing the inverter installation location. It is recommended that using a sun shade minimizing direct sunlight when the ambient air temperature around the unit exceeds 104°F/40°C.



- Install on a wall or strong structure capable of bearing the weight.
- Install vertically with a maximum incline of +15°. If the mounted inverter is tilted to an angle greater than the maximum noted, heat dissipation can be inhibited, and may result in less than expected output power.
- If install more than one inverter, must leave at least 500mm gap between each inverter. And each inverter must be at least 500mm above and below. And must install the inverter at the place where children cannot touch. Please see picture 4.3.
- Consider whether the installation environment is helpful to see the inverter LCD display and indicator status clearly.
- Must offer a ventilate environment if inverter installed in the airtight house.



**Safety Hint:**

Do not place or store any items next to the inverter.

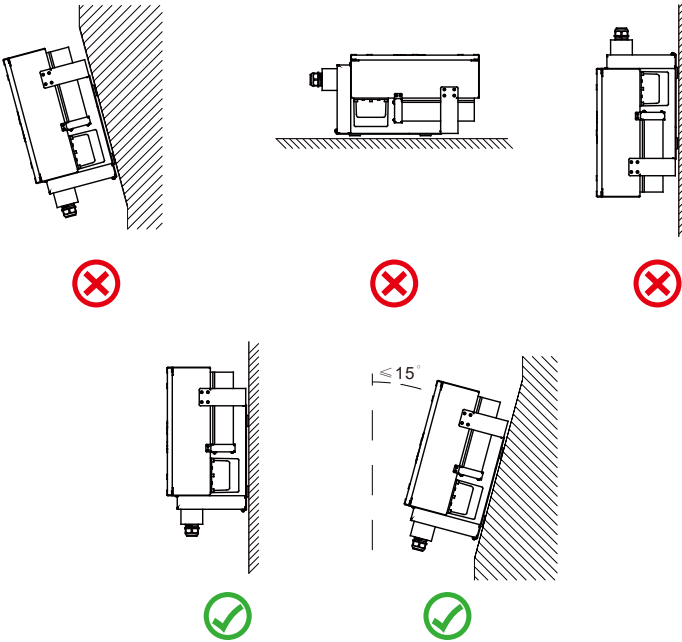

Pic 4.2 Installation Angle

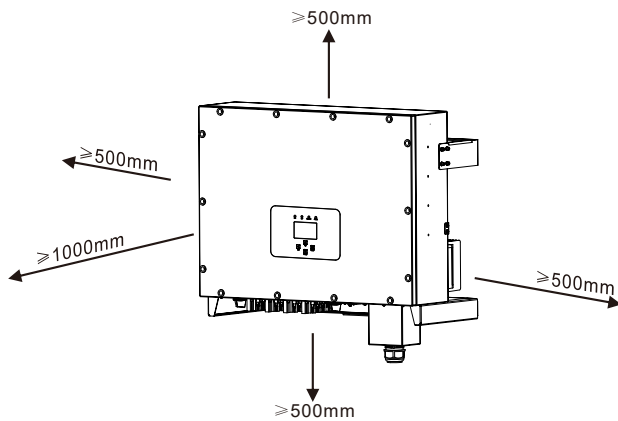

Pic 4.3 Installation Gap

## 4.2 Mounting bracket of inverter

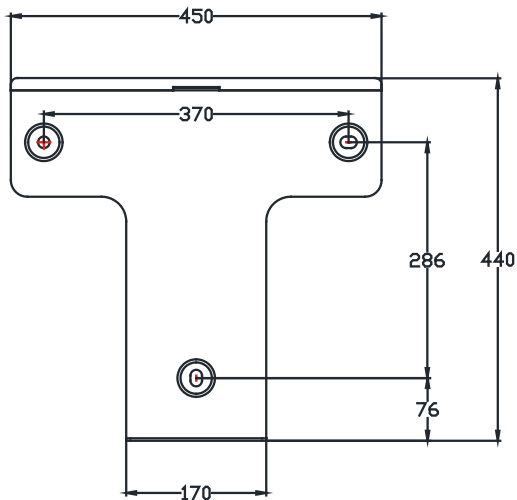













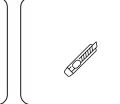
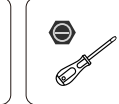

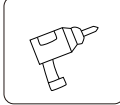
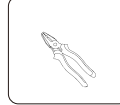
Pic 4.4 Mounting bracket dimensions

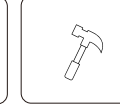
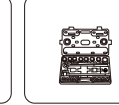
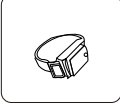
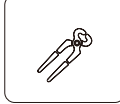
### 4.3 Installations Tools

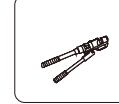
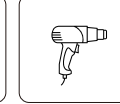
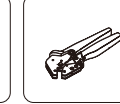
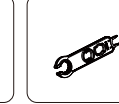
Installation tools can refer to the following recommended ones. Also, use other auxiliary tools on site.

table 4-1 Tool specification

						
Protective goggles	Anti-dust mask	Earplugs	Work gloves	Work shoes	Utility Knife	Slotted screwdriver
						
Cross screwdriver	Percussion drill	Pliers	Marker	Level	Rubber hammer	socket wrenches set
						
Anti-static wrist strap	Wire cutter	Wire stripper	Hydraulic pliers	Heat gun	Crimping tool4-6mm <sup>2</sup>	Solar connector wrench
						
Multimeter ≥1100 Vdc	RJ45 crimping plier	Cleaner				

### 4.4 Inverter Installation

The inverter should be mounted in a vertical position. The steps of mounting are as follows

1. For brick walls, the position of the holes should be suitable for the expansion bolts.
2. Make sure the bracket is horizontal and the mounting holes are in the correct points. Drilling the holes on the wall according the marks.
3. Using the expansion bolts to fix the bracket to the wall.

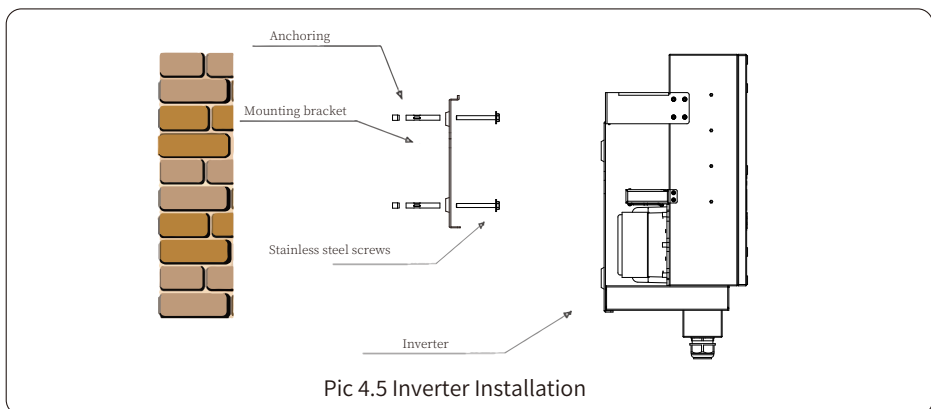

Pic 4.5 Inverter Installation

## 5. Electrical Connection

### 5.1 DC input terminal connection

1. Switch the Grid Supply Main Switch(AC)OFF.
2. Switch the DC Isolator OFF.
3. Assemble PV input connector to the inverter.



**Warning:**

When using PV modules, please ensure the PV+ & PV- of solar panel is not connected to the system ground bar.



**Safety Hint:**

Before connection, please make sure the polarity of the output voltage of PV array matches the “DC+” and “DC-” symbols.



**Warning:**

Before connecting inverter, please make sure the PV array open circuit voltage is within the 1000V of the inverter.

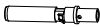
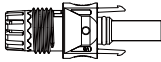

Pic 5.1 DC+ male connector

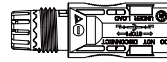

Pic 5.2 DC- female connector



**Safety Hint:**

Please use approved DC cable for PV system.

Cable type	Cross section (mm <sup>2</sup> )	
	Range	Recommended value
Industry generic PV cable (model: PV1-F)	2.5-4.0 (12-10AWG)	2.5(12AWG)

Table 5.1 DC Cable Specifications

The steps to assemble the DC connectors are listed as follows:

a) Strip off the DC wire about 7mm, disassemble the connector cap nut (see picture 5.3).

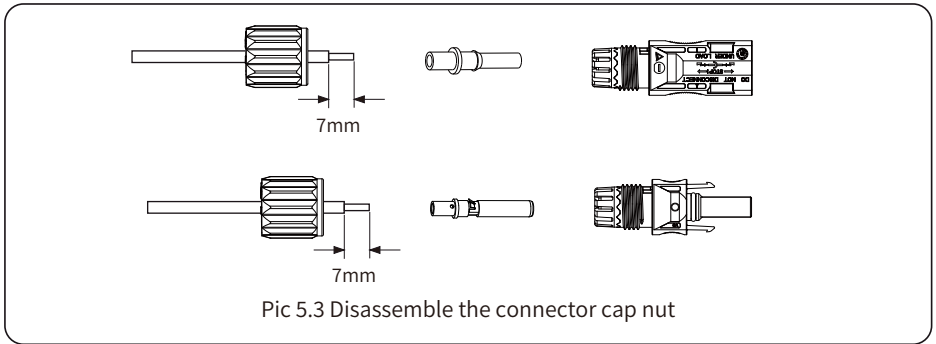

b) Crimping metal terminals with crimping pliers as shown in picture 5.4.

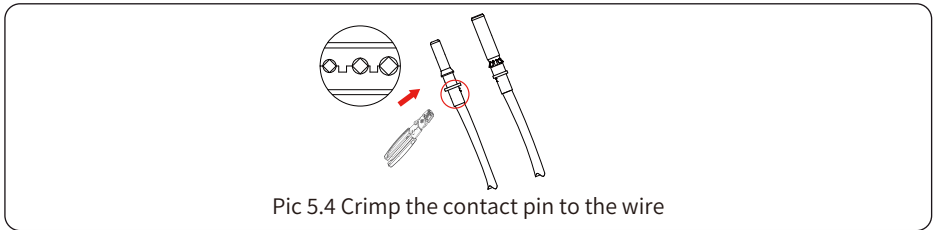

c) Insert the contact pin to the top part of the connector and screw up the cap nut to the top part of the connector. (as shown in picture 5.5).

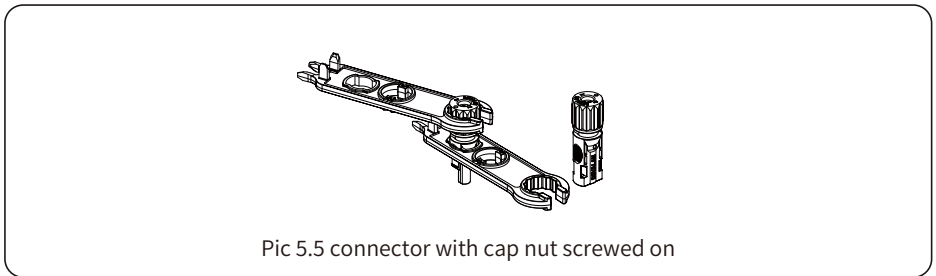

d) Finally insert the DC connector into the positive and negative input of the inverter, shown as picture 5.6

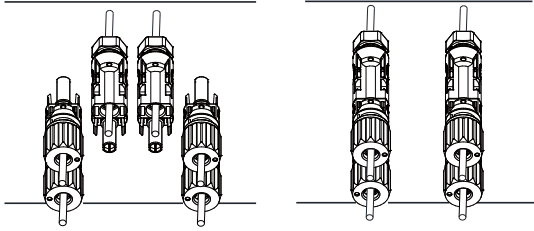

Pic 5.6 DC input connection



**Warning:**

Sunlight shines on the panel will generate voltage, high voltage in series may cause danger to life. Therefore, before connecting the DC input line, the solar panel needs to be blocked by the opaque material and the DC switch should be 'OFF', otherwise, the high voltage of the inverter may lead to life-threatening conditions.



**Warning:**

Please use its own DC power connector from the inverter accessories. Do not interconnect the connectors of different manufacturers. Max. DC input current should be 20A. if exceeds, it may damage the inverter and it is not covered by Deye warranty.

### 5.2 AC terminal connection

Model	Wire Size	Recommend copper cable(mm <sup>2</sup> )	Torque value(max)
SUN-60K-G	2AWG	25	16.9Nm
SUN-70K-G	1AWG	35	16.9Nm
SUN-75K-G	1AWG	35	16.9Nm
SUN-80K-G	0AWG	50	20.3Nm

Table 5.2 Recommended cable specifications



**Warning:**

The AC cable line L1 is connected to socket 1; L2 is connected to socket 2; L3 is connected to socket 3, the PE line is connected to the earth, the N wire is connected to the socket of N.



AC wire installation method:

1) Remove the 8 screws on the inverter junction box and remove the junction box cover in Pic 5.7. After removing the junction box, you can see the terminals of the inverter. The default is 4 digits as shown in Pic 5.8.

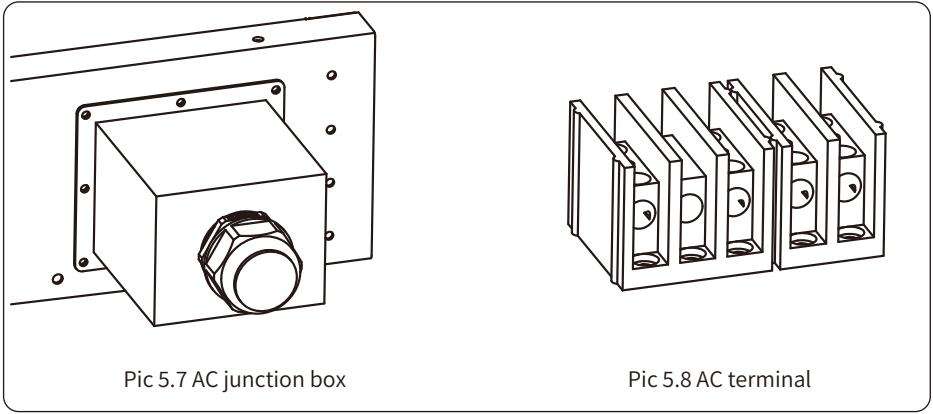

2) Connect the cable through the junction box, waterproof jacket, and insert into the terminal (The picture Pic 5.9 shows the connection mode of three phase lines connected to the junction box, ground wire screwed on the inverter shell), and use hexagon screwdriver to presses the wiring harness to the connect terminal as shown in Pic 5.10.

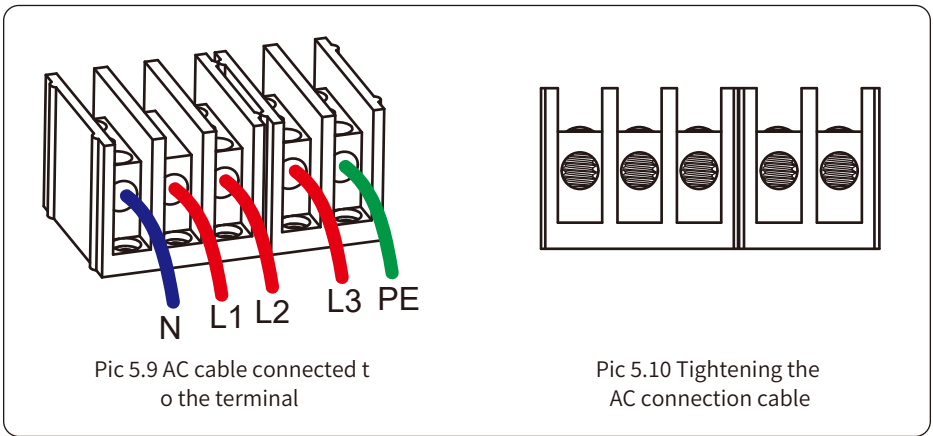

3) Screw the AC connection cover back to the shell and tighten all the screws to tighten the waterproof protection connector, as shown in Pic 5.11

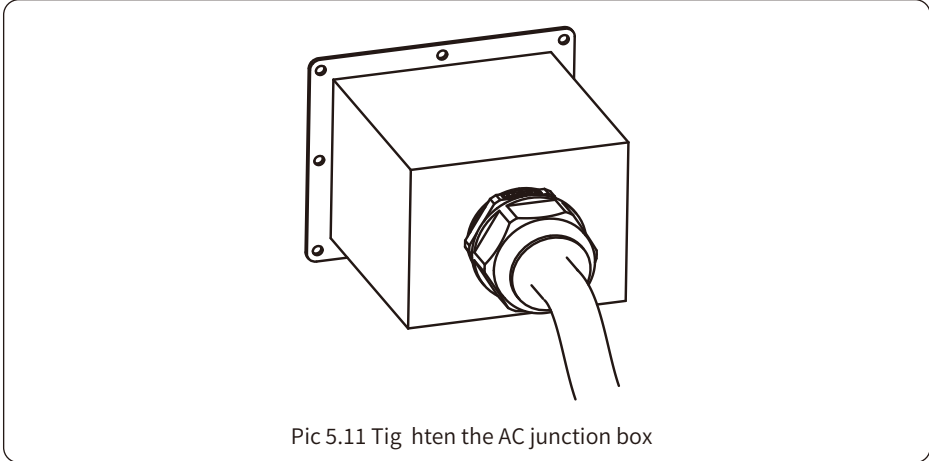

Pic 5.11 Tighten the AC junction box

### 5.2.1 Recommended current protector specifications

Inverter	Rated voltage	Rated output power (KW)	Current protection device (A)
SUN-60K-G	400	60	120
SUN-70K-G	400	70	150
SUN-75K-G	400	75	150
SUN-80K-G	400	80	160

Table 5.3 Recommended current protector specifications

### 5.3 Connection of the ground line

Good grounded is important for resist the surge voltage shock and improve EMI's performance. So before the connection of AC, DC, communication connections, inverter needs to ground first. For a single system, just ground the PE cable; For multiple machine systems, all PE cables of the inverter need to be connected to the same grounding copper platoon to ensure the equipotent connection. The installation of the shell ground wire is shown as Pic 5.12. The external protective earthing conductor is made of the same metal as the phase conductor.

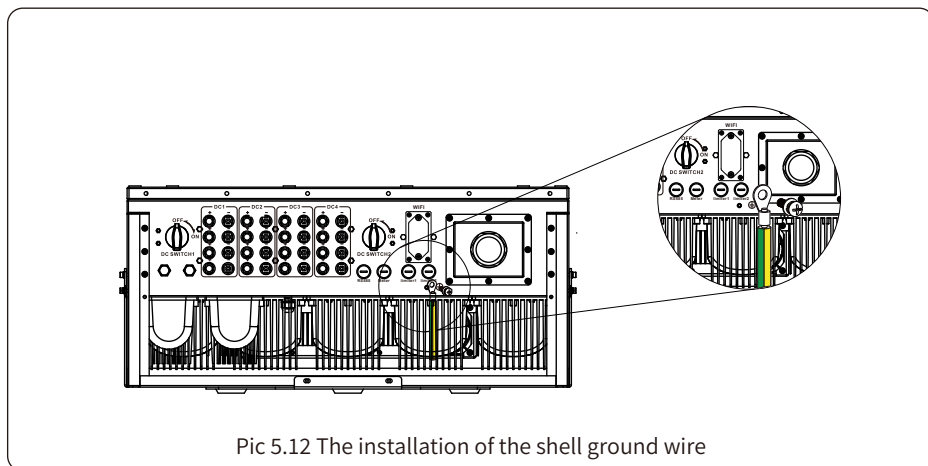

Model	Wire Size	Recommend copper cable(mm <sup>2</sup> )	Torque value(max)
SUN-60K-G	4AWG	16	12.4Nm
SUN-70K-G	4AWG	16	12.4Nm
SUN-75K-G	4AWG	16	12.4Nm
SUN-80K-G	2AWG	25	16.9Nm

Table 5.3 Recommended cable specifications



#### Warning:

Inverter has built-in leakage current detection circuit, The type A RCD can be connected to the inverter for protection according to the local laws and regulations. If an external leakage current protection device is connected, its operating current must be equal to 300 mA or higher, otherwise inverter may not work properly.

## 5.4 Inverter monitoring connection

Inverter has the function of wireless remote monitoring inverter. The inverter has Wifi function and Wifi Plug in the accessories is used to realize the connection between the inverter and the network. The operation, installation, networking, APP download are detailed in the WIFI PLUG instructions. Figure 5.13 is the Internet monitoring solution.

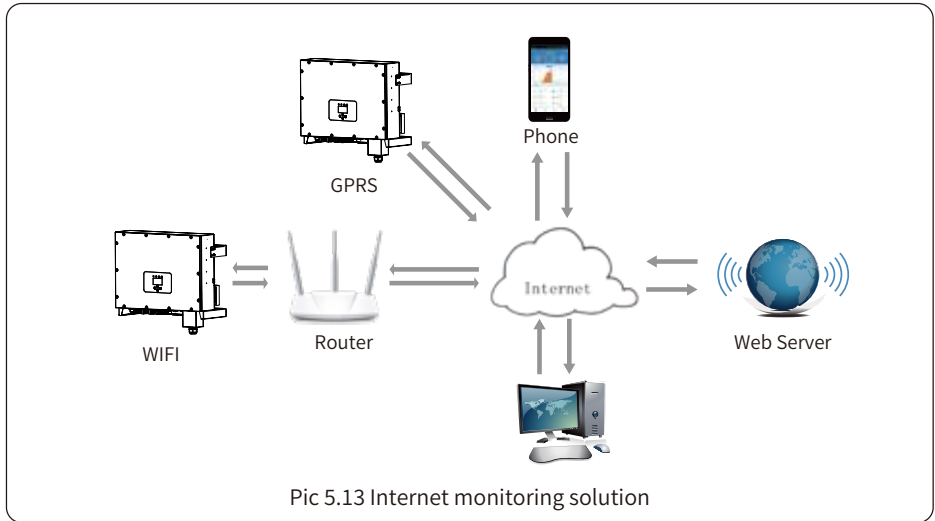

### 5.4.1 Installation of datalogger

When installing the WiFi stick, tear off the sealing strip on the inverter. Insert the datalogger into the interface and fix it with a screw. The configuration of the datalogger needs to be performed after various electrical connections have been completed and the inverter DC power on. When the inverter is on the DC power, it is determined whether the datalogger is normally electrified (The LED light shines out of the shell).

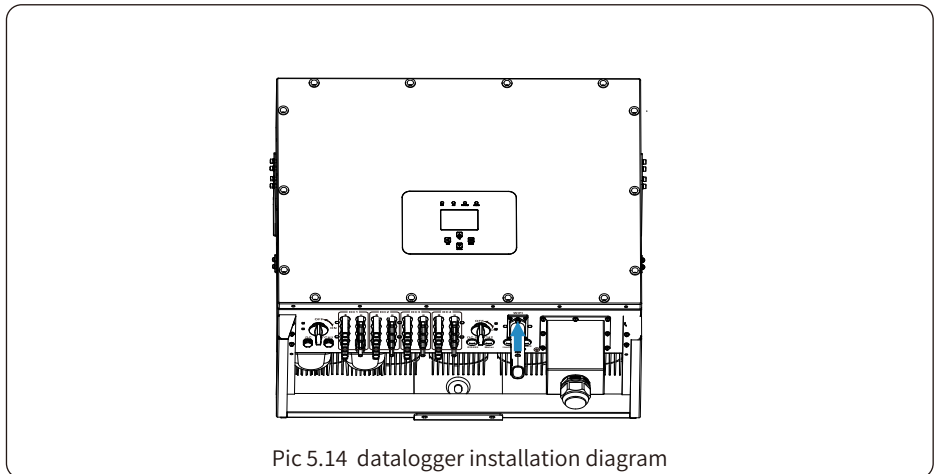

---

## 5.4.2 Configuration of datalogger

For the configuration of datalogger, please refer to illustrations of the datalogger.

## 6. Start up and Shut off

Ensure that the inverter meets the following conditions before starting the inverter, otherwise it may cause fire or damage to the inverter without quality assurance, at the same time the situation on our company does not undertake any responsibility. At the same time, to optimize the system configuration, it is recommended that the two inputs be connected to the same number of PV modules.

- a). The maximum open circuit voltage of each set of PV modules shall not exceed 1000Vdc under any conditions.
- b). Each input of the inverter better use the same type of PV module in series.
- c). Total output power of PV shall not exceed the maximum input power of inverter, each PV modules shall not exceed the rated power of each channel.

### 6.1 Start up the inverter

When starting up the inverter, should follow steps below:

1. Starting switch on the AC breaker.
2. Turn on the DC switch of the PV module, and if the panel provides sufficient starting voltage and power, the inverter will start.
3. The inverter will first check the internal parameters and the grid parameters, while the liquid crystal will show that the inverter is self-checking.
4. If the parameter is within acceptable range, the inverter will generate energy. NORMAL indicator light is on.

### 6.2 Shut off the inverter

Must follow below steps while Shutting down the inverter:

1. Switch off the AC breaker.
2. Wait for 30 seconds, turn off the dc switch (if any), or simply disconnect the dc input connector. The inverter will close the LCD and all led within two minutes.

### 6.3 Anti-PID Function(option)

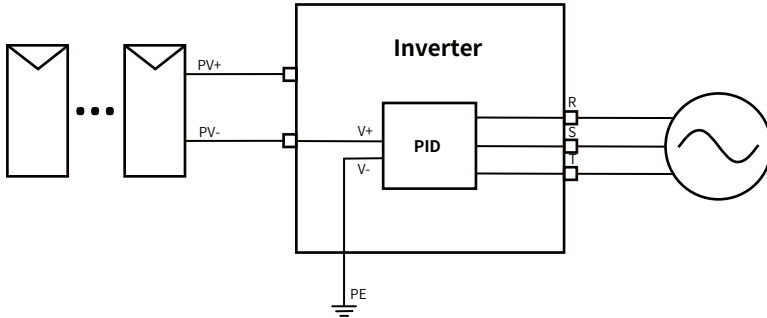

The Anti-PID module repairs the PID effect of the PV module at night. The PID module always runs when connected to AC.

If maintenance is required and turn off the AC switch can disable the Anti-PID function.



**Warning:**

The PID functionality is automatic. When the DC bus voltage is below 50VDC, the PID module will create 450VDC between the PV and ground. No control and equipment are required.



**Warning:**

If you need to maintain the inverter, Please turn off the AC switch first, then turn off the DC switch, and wait 5 minutes before you do other operations.

## 7. Zero-export function via energy meter

There're four kinds of energy meters for this series inverter. First type is Eastron SDM630-Modbus V2 which is able to measure the Max. 200A current directly. More details please refer to Pic 7.1 & 7.4. For the Eastron SDM630 MCT 40mA, it needs external CT to measure the current. The CT power range is from 5A-2000A. More details about the Eastron SDM630 MCT, please refer to Pic 7.5 & 7.8. Also, the CHNT meter DTSU666 is supported, it can measure the Max. 80A current directly. More details about the DTSU666, please refer to Pic 7.9 - 7.16.

When you are reading this, we believe that you have completed the connection according to the requirements of chapter 5, if you have been running your inverter at this time, and you want to use the zero-export function, please turn off AC and DC switch of the inverter, and wait for 5 minutes until the inverter completely discharged.

For system wiring diagram, the red line refers to L line (L1, L2, L3), the black line refers to the neutral line (N). Connecting energy meter RS485 cable to inverter's RS485 port. It's recommended to install an AC switch between the inverter and the utility grid, the specs of the AC switch are determined by the power of load.

If there is no integrated DC switch inside the inverter you purchased, we commend you to connect the DC switch. The voltage and current of the switch depend on the PV array you access.

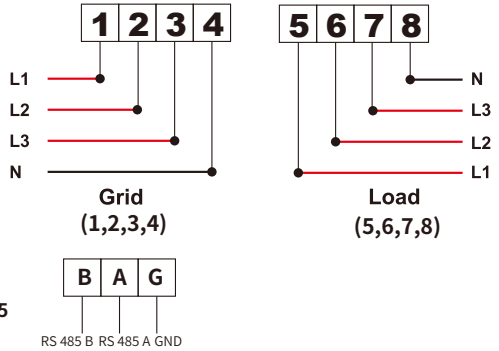

Eastron SDM630-Modbus V2

Pic 7.1 Eastron meter

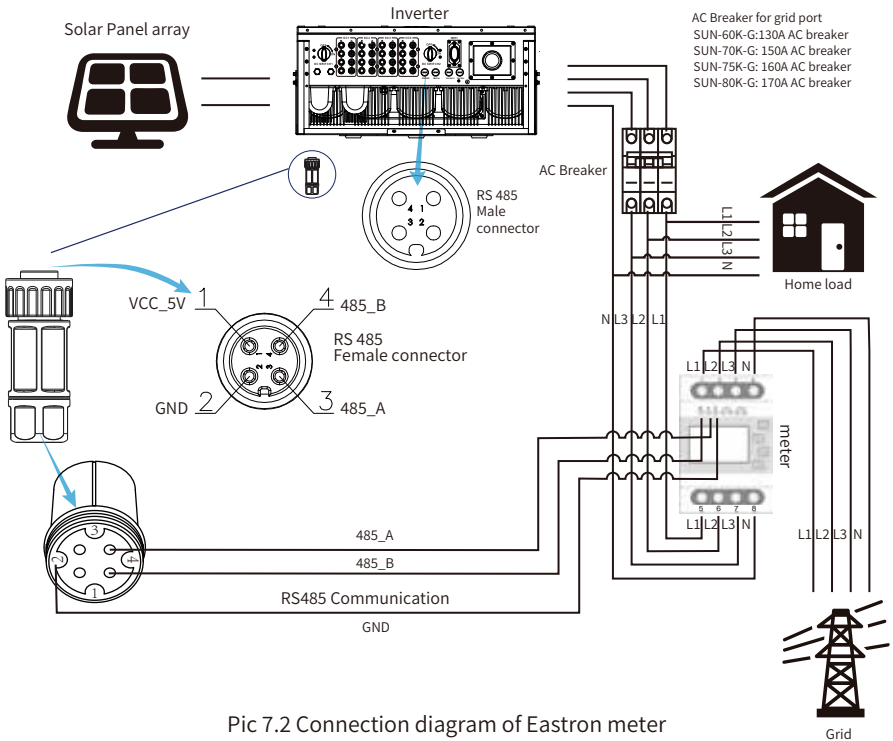

Pic 7.2 Connection diagram of Eastron meter



**Warning:**

In final installation, breaker certified according to IEC 60947-1 and IEC 60947-2 shall be installed with the equipment.

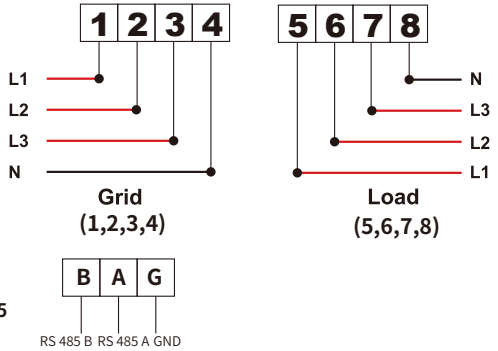

Eastron SDM630-Modbus V2

Pic 7.3 Eastron meter

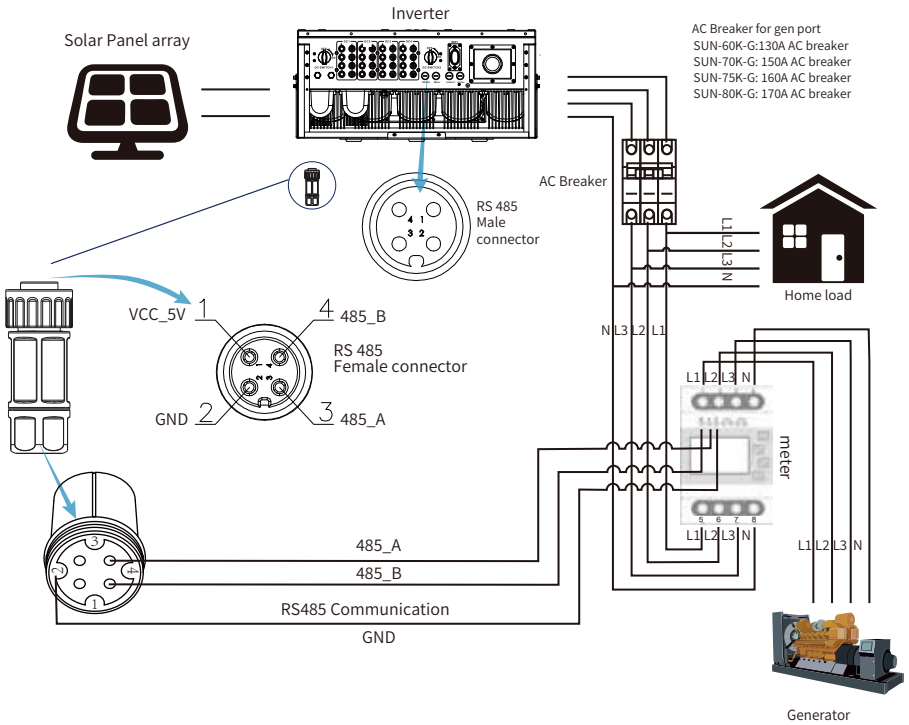

Pic 7.4 Connection diagram of Eastron meter



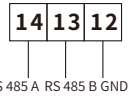
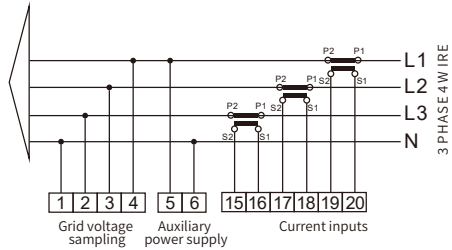
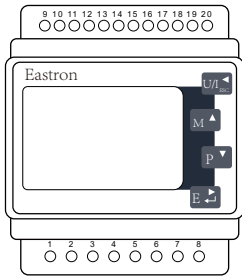

Eastron SDM630MCT

Pic 7.5 Eastron meter

Solar Panel array

Inverter

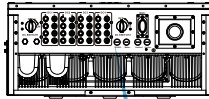

AC Breaker for grid port  
 SUN-60K-G: 130A AC breaker  
 SUN-70K-G: 150A AC breaker  
 SUN-75K-G: 160A AC breaker  
 SUN-80K-G: 170A AC breaker

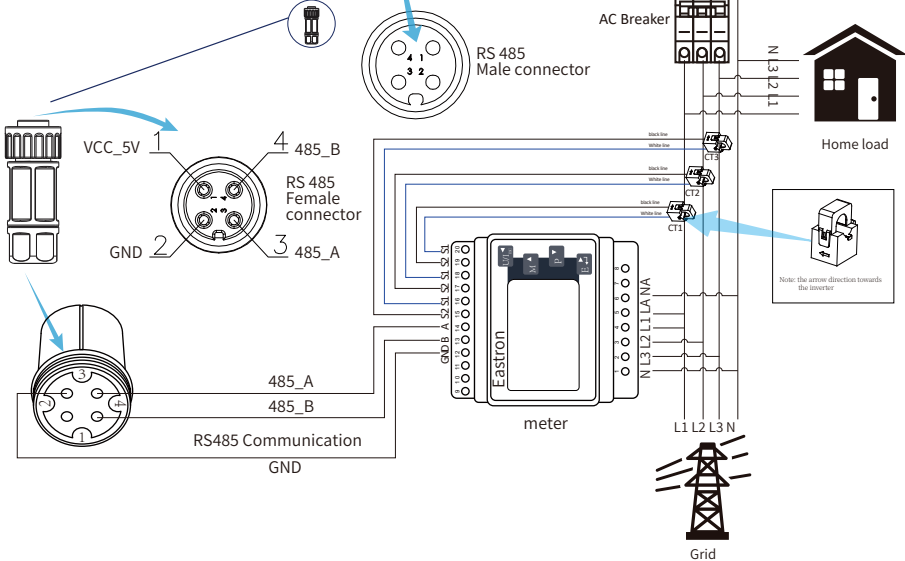

Pic 7.6 Connection diagram of Eastron meter

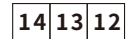
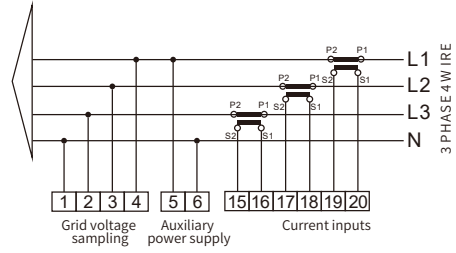
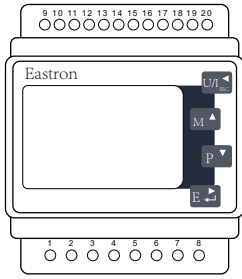

RS 485

RS 485 A RS 485 B GND

Eastron SDM630MCT

Pic 7.7 Eastron meter

Solar Panel array

Inverter

AC Breaker for gen port  
 SUN-60K-G: 130A AC breaker  
 SUN-70K-G: 150A AC breaker  
 SUN-75K-G: 160A AC breaker  
 SUN-80K-G: 170A AC breaker

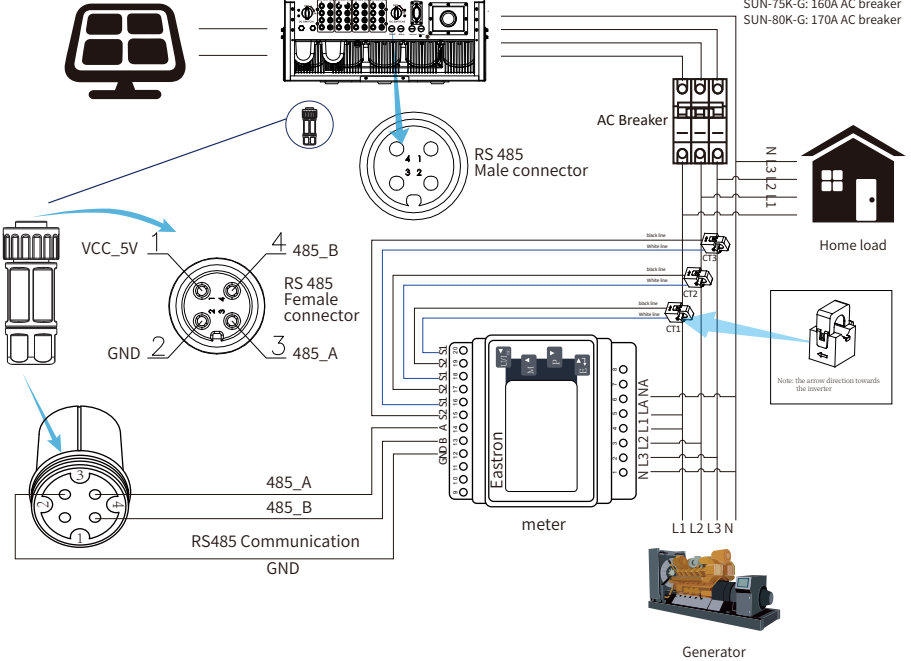

Pic 7.8 Connection diagram of Eastron meter

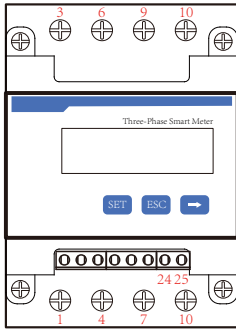

CHNT DTSU666

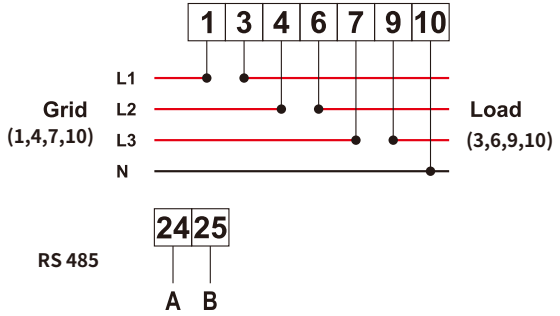

Pic 7.9 CHNT meter

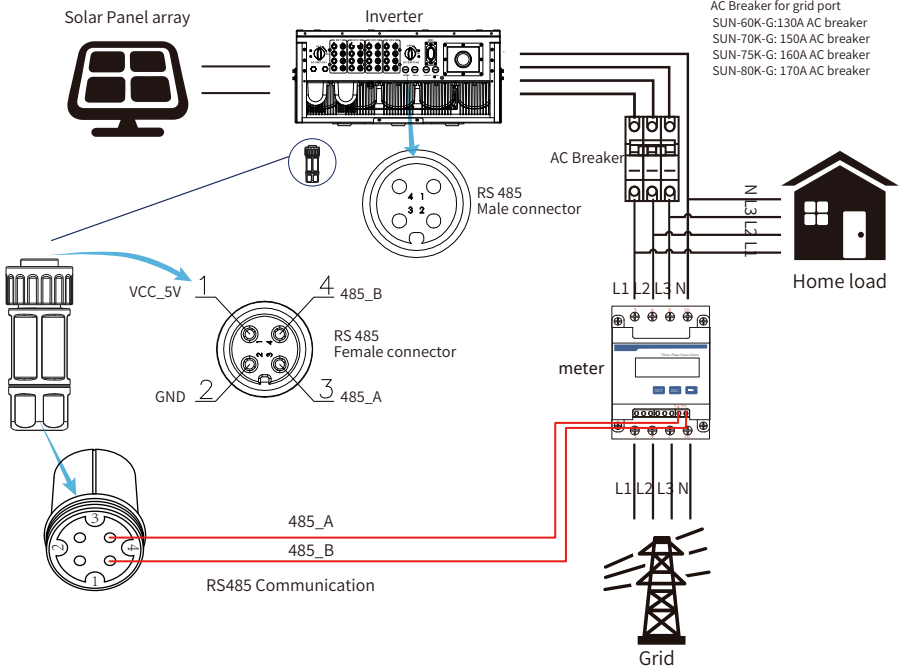

Pic 7.10 Connection diagram of CHNT meter

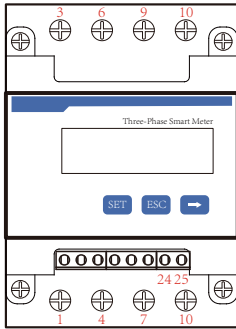

CHNT DTSU666

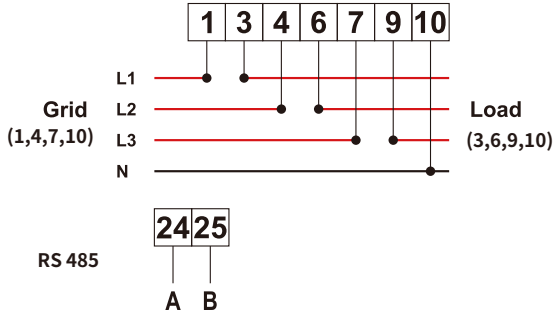

Pic 7.11 CHNT meter

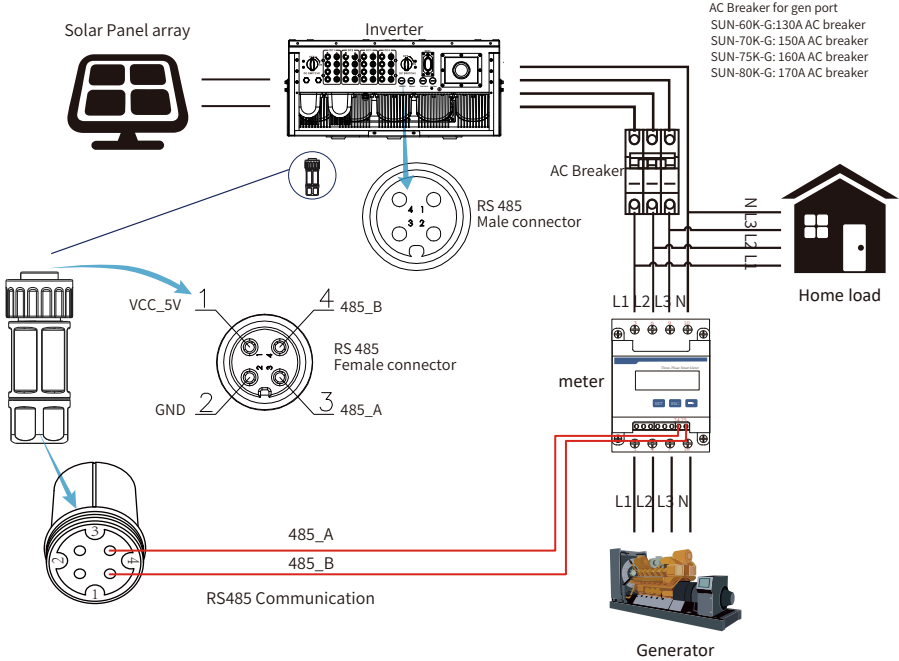

Pic 7.12 Connection diagram of CHNT meter

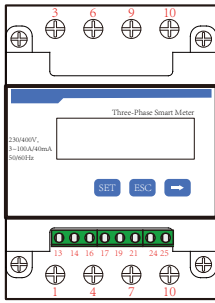

**CHNT DTSU666**  
3x230/400V  
100A/40mA

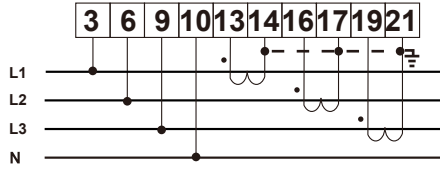

1A 5.000 A

Phase A current =5.000A

1B 5.001 A

Phase B current =5.001A

1C 5.002 A

Phase C current =5.002A

Pic 7.13 CHNT meter

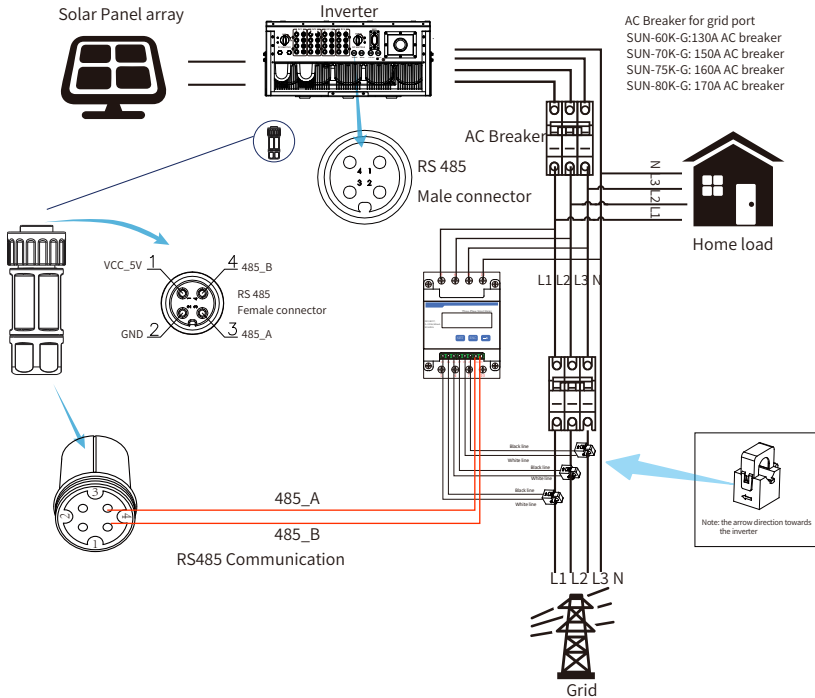

Pic 7.14 Connection diagram of CHNT meter

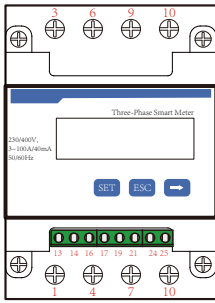

CHNT DTSU666  
3x230/400V

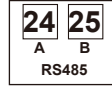
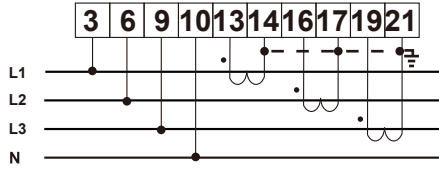

1A 5.000 A  
Phase A current =5.000A

1B 5.001 A  
Phase B current =5.001A

1C 5.002 A  
Phase C current =5.002A

Pic 7.15 CHNT meter

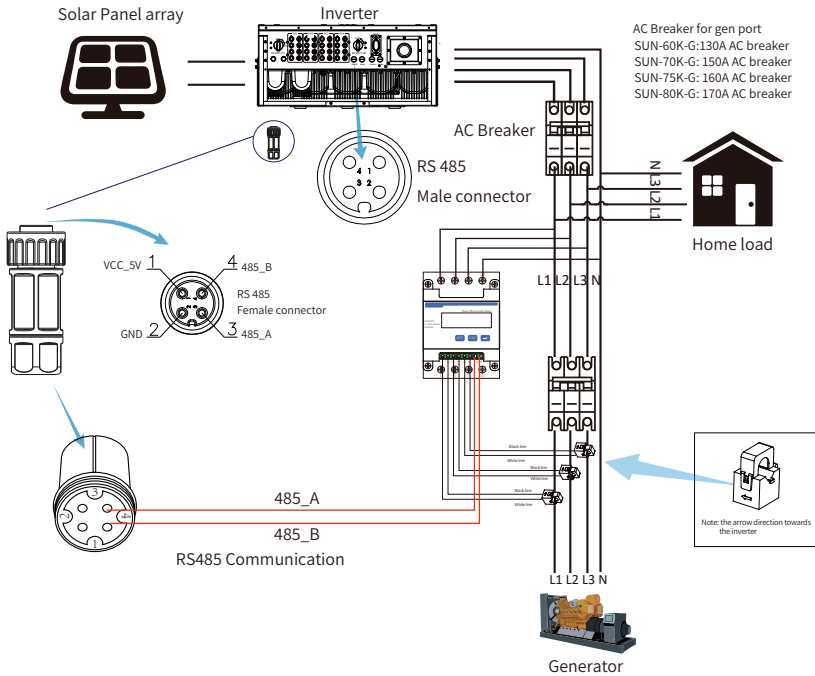

Pic 7.16 Connection diagram of CHNT meter



**Safety Hint:**

Ensuring grid input cables connect 1/4/7/10 port of energy meter, and inverter AC output cables connect 3/6/9/10 port of energy meter when connecting.

1. Press Enter button on the LCD panel in the main interface into the menu options, select [parameter setting] to enter setup submenu, and then select [run\_param], at this time please input the default password 1234 through pressing the button [up down, enter], enter the operation parameter setting interface, shown as picture 7.17.

MENU» Setup» Run Param			
ActiveP	31%	SelfCheck	20S
QMode	QU	Island	OFF
ReactP	0.0%	Meter	ON
PF	1.000	Limiter	OFF
Fun_ISO	ON	Feed_In	0%
Fun_RCD	ON	MPPT Num	4
OK		Cancel	

Pic 7.17 Zero-export function via meter setting interface

2. Operate the button [up down], move setting cursor to energy meter and press the button [enter]. At this time you can turn on the energy meter by choosing [up down] button, please press [enter] button to confirm when setting done.
3. Move the cursor to [OK], press [enter] to save the settings and exit the running parameters page, otherwise the settings are invalid.
4. If set up successfully, you can return to the menu interface, and display the LCD to [home page] by press the [up down] button. If it displays [meter power XXW], the zero-export function setting is completed. Shown as picture 7.18.

PARAMETR	Meter
	SN:1
Meter Power:	428W
Load Power:	1.043kW
	Day Total
ImpEp : 9.51kWh	2.24MWh
ExpEp : 0.00kWh	574.75KWh
LoadEp : 13.71kWh	1.67MWh

Pic 7.18 Zero-export function via energy meter turn on

5. Meter power 428W shows positive means grid is supplying the load, and no power fed into grid. if meter power shows negative, it means PV energy is being sold to grid or energy meter wiring connection has problem.
6. After properly connection is done, wait for inverter starting. If the power of the PV array meets the current power consumption, the inverter will keep a certain output to counteract the power of the grid without backflow .

## 7.1 Multiple strings and parallel connection meters

This application is that when the string inverters work in parallel, there is only one power grid and one load, and only one meter can be connected to prevent reverse current, so only this many-to-one anti-reverse current connection can be connected.

If there're several inverters paralleling operation in a plant, also it can use 1pcs meter to realize zero export function. For example, if there're 3pcs inverters paralleling operation in the system with 1pcs meter. We need to setup 1pcs inverter as the master and others setup as slaves. And, all of them need to connect to the meter via RS485. Below is the system diagram and configuration of the system.

MENU Setting			
Exp_Mode	AVG	Generator	ON
CT_Ratio	1	G.CT	1
MFR	AUTO	G.MFR	AUTO
FeedIn	0.0KW	G.Pout	0%
Shunt	OFF	G.Cap	200.0 KW
ShuntQTY	3		
	Back		

Pic 7.19 Meter function



<b>Name</b>	<b>Description</b>	<b>Range</b>
<b>Exp_Mode</b>	AVG: Average power of three phase is zero exported. MIN: Phase with minimum load power is zero exported, while the other two phase may be in purchase mode.	AVG/MIN
<b>CT_Ratio</b>	CT ratio of power grid side meter when extern CT is applied.	1-1000
<b>MFR</b>	Manufacturer of the grid side meter. Modbus Address of it should be set as 01.	AUTO/CHNT/ EASTRON
<b>Feedin</b>	Percentage of the Feed in power exported to the grid.	0-110%
<b>Shunt</b>	Parallel mode. Set one inverter as Master, others are Slave. ONLY need to set the master, Slave will follow the settings in the master.	OFF/Master/ Slave
<b>ShuntQTY</b>	Number of inverters in parallel	1-16
<b>Generator</b>	DG side meter function Enable/Disable	ON/OFF
<b>G.CT</b>	CT ratio of power DG side meter when extern CT is applied.	1-1000
<b>G.MFR</b>	Manufacturer of the DG side meter. Modbus Address of it should be set as 02.	AUTO/CHNT/ EASTRON
<b>G.Pout</b>	Output power percentage of the DG.	0-110%
<b>G.Cap</b>	Capacity of the DG.	1-999kW

**Note:** Select Meter option in Run Param and long press ENTER button to enter this Meter Setting page.

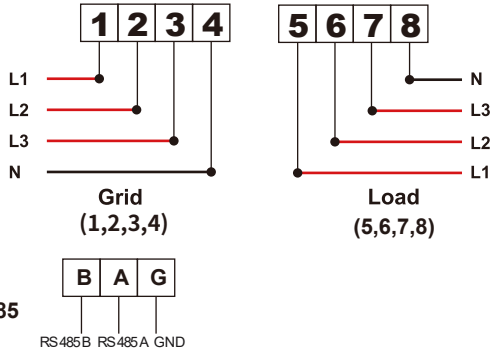

Eastron SDM630-Modbus V2 Pic 7.20 Eastron meter

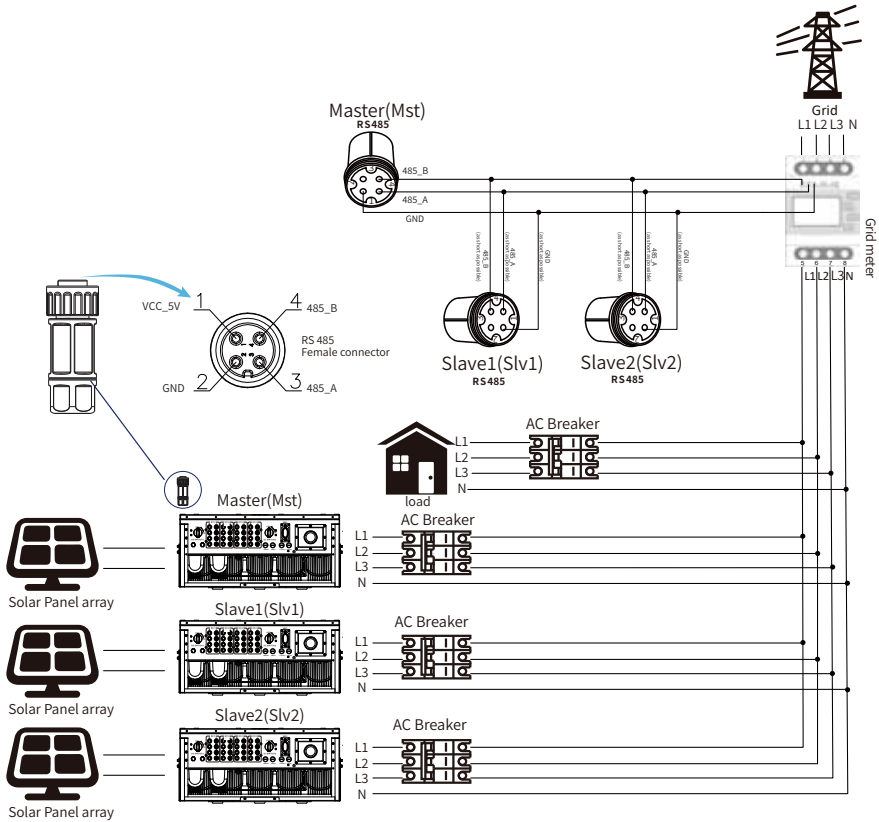

Pic 7.21 Eastron Connection diagram(The pass-through table)

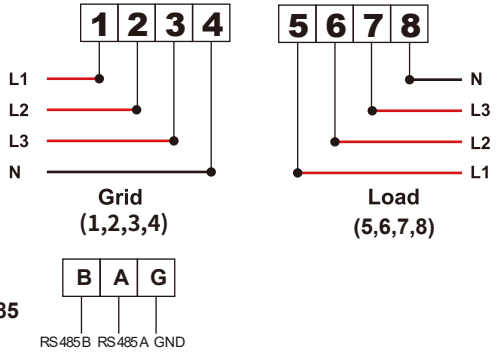

Eastron SDM630-Modbus V2 Pic 7.22 Eastron meter

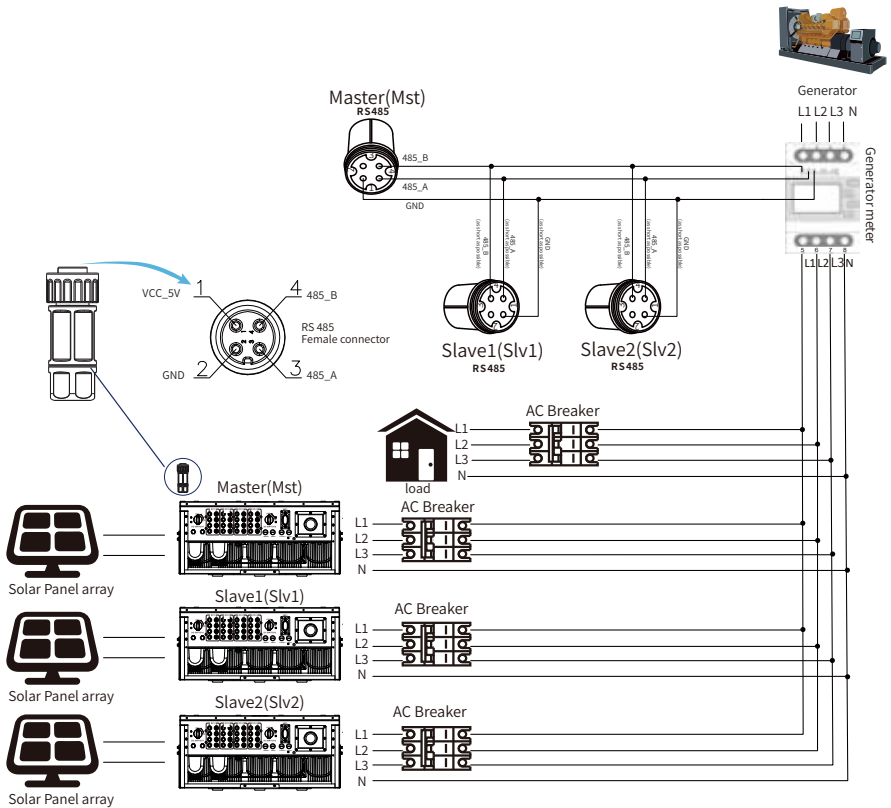

Pic 7.23 Eastron Connection diagram(The pass-through table)

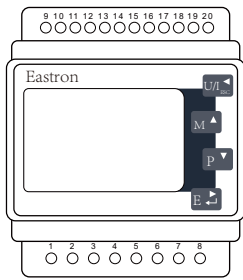

Eastron SDM630MCT

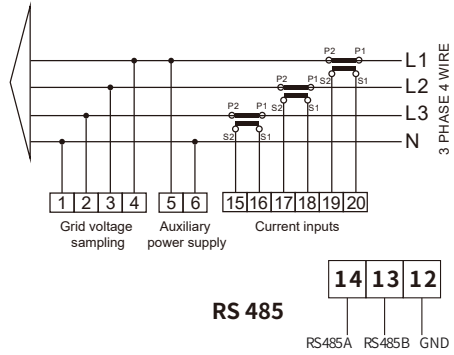

Pic 7.24 Eastron meter

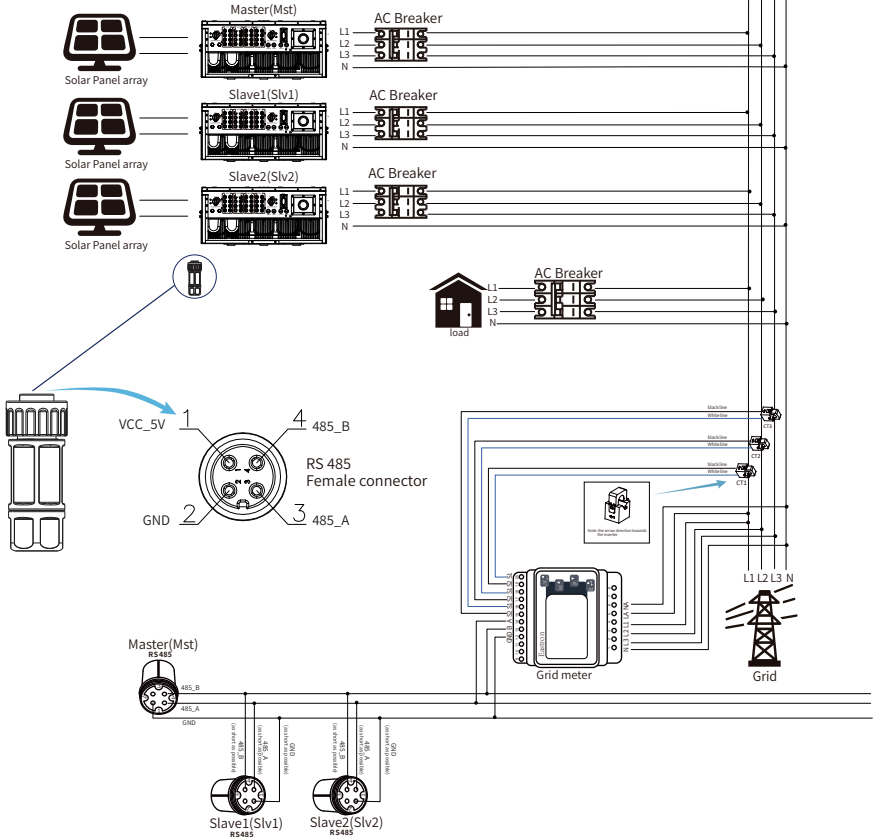

Pic 7.25 Connection diagram(Three-phase electricity)

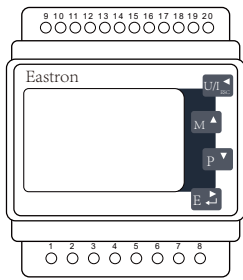

Eastron SDM630MCT

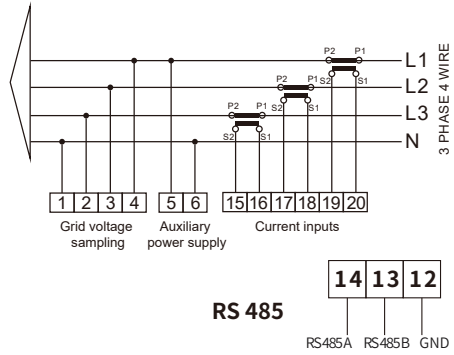

Pic 7.26 Eastron meter

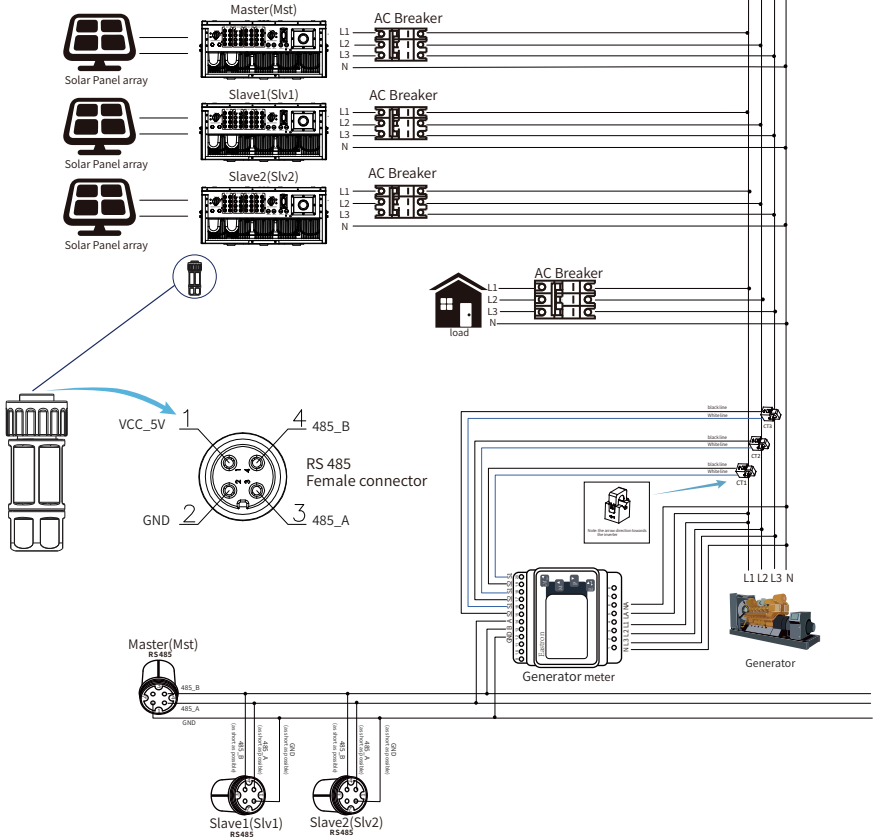

Pic 7.27 Connection diagram(Three-phase electricity)

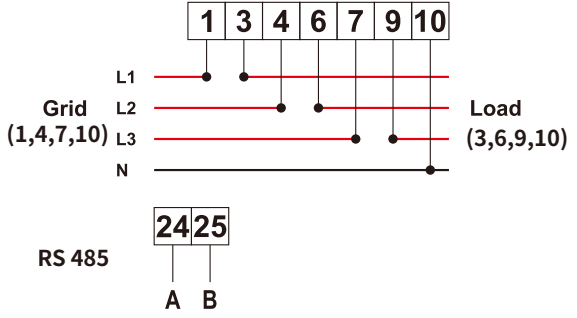
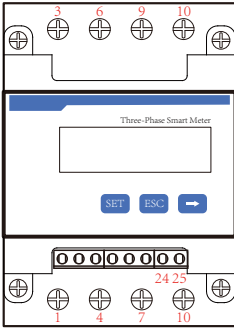

CHNT DTSU666

Pic 7.28 CHNT meter

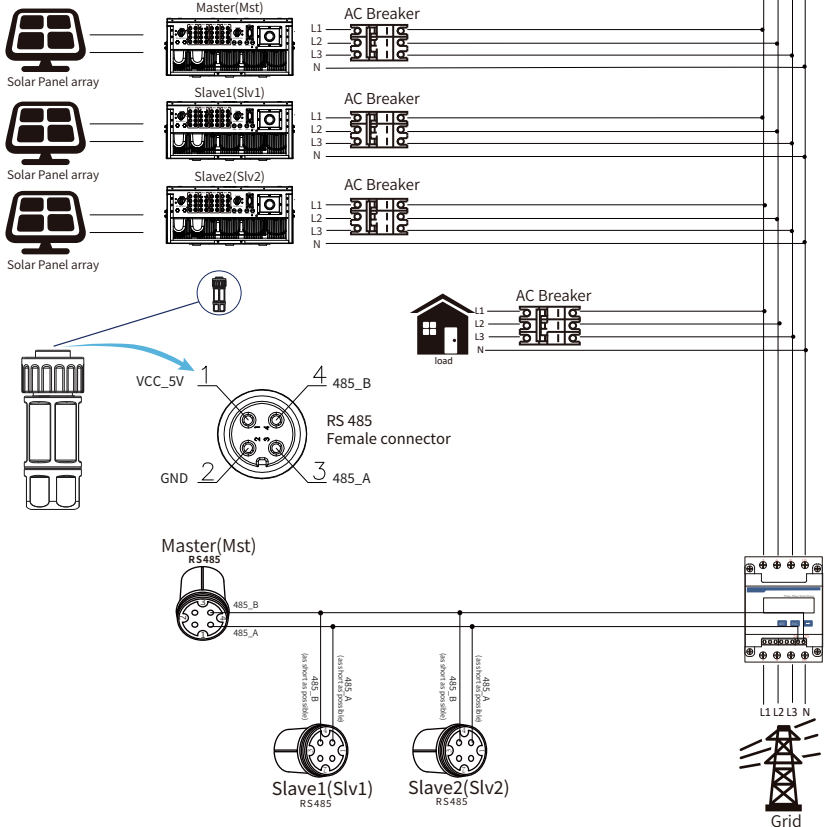

Pic 7.29 CHNT Connection diagram(The pass-through table)

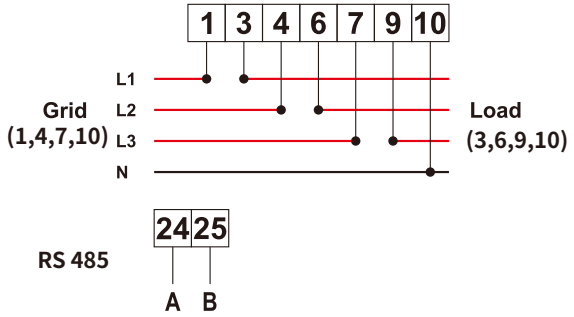
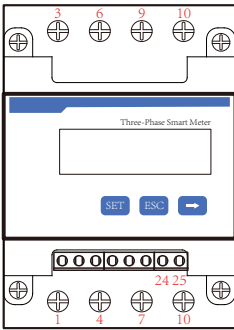

CHNT DTSU666

Pic 7.30 CHNT meter

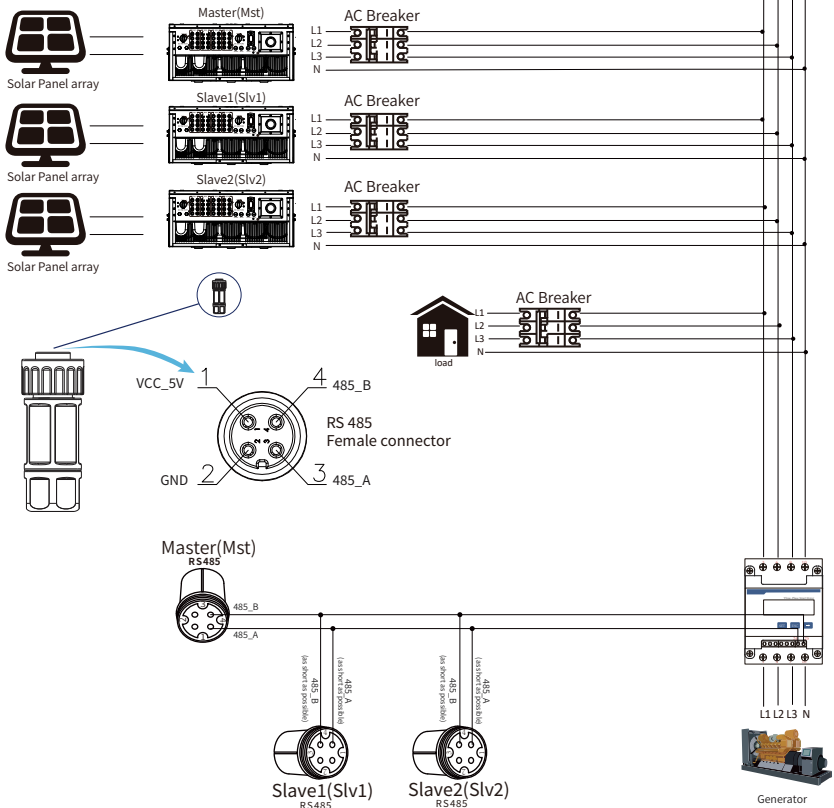

Pic 7.31 CHNT Connection diagram(The pass-through table)

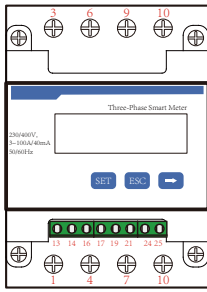

CHNT DTSU666  
3x230/400V

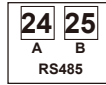
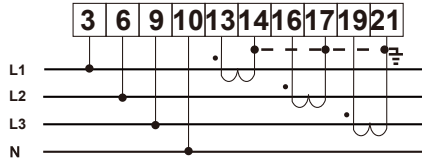

1A 5.000 A

Phase A current =5.000A

1b 5.001 A

Phase B current =5.001A

1c 5.002 A

Phase C current =5.002A

Pic 7.32 CHNT meter

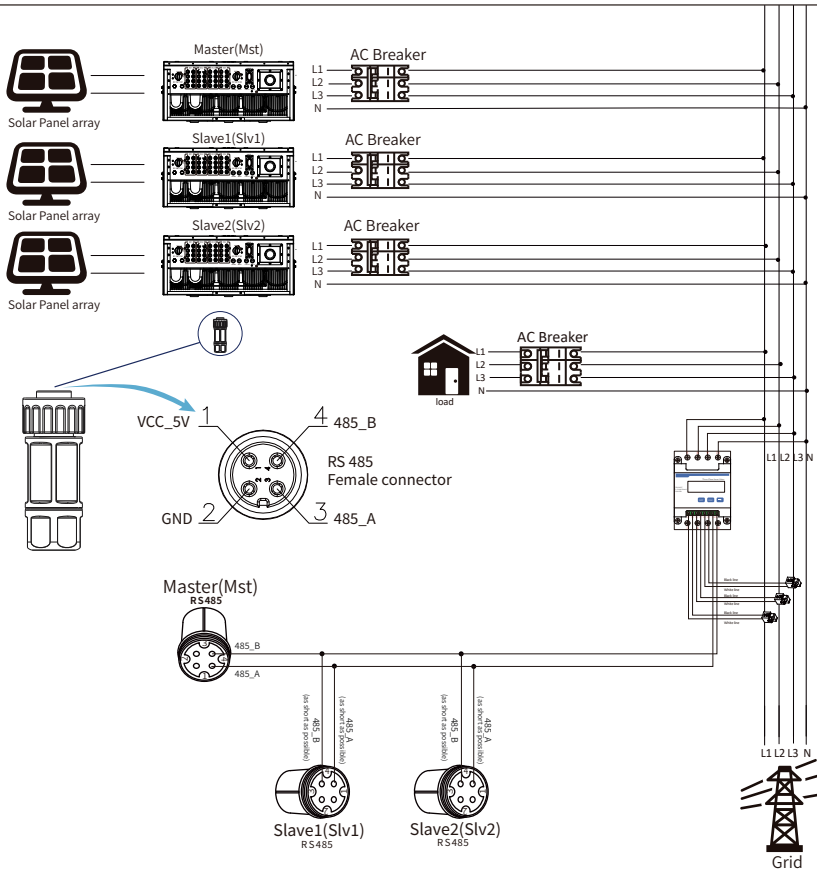

Pic 7.33 CHNT Connection diagram(The pass-through table)



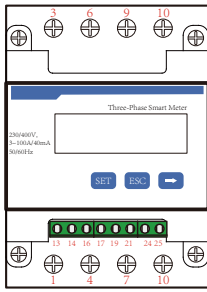

CHNT DTSU666  
3x230/400V

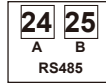
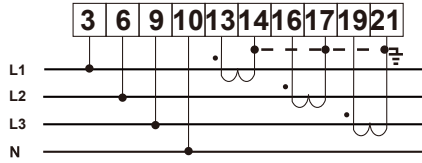

1A 5.000 A

Phase A current =5.000A

1b 5.001 A

Phase B current =5.001A

1c 5.002 A

Phase C current =5.002A

Pic 7.34 CHNT meter

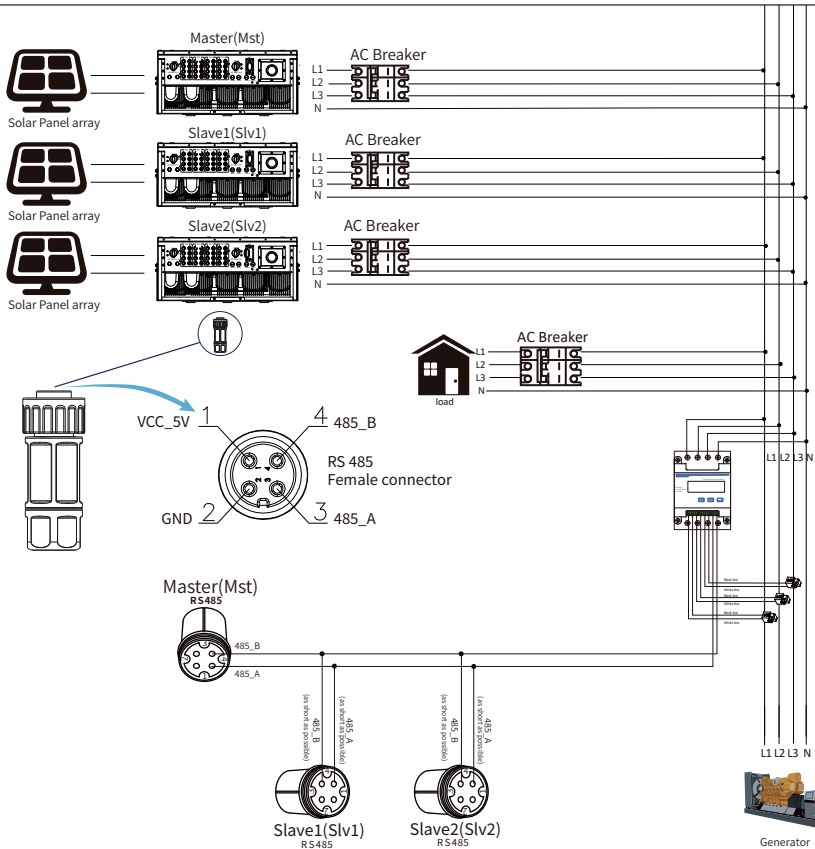

Pic 7.35 CHNT Connection diagram(The pass-through table)

## 7.2 How to browse the load power of your PV grid-tie plant on monitoring platform?

If you want to browse load power of the system and how much energy (KWH) does it export to grid (inverter output power is used to power the load firstly and then the surplus energy will feed into grid). You also need to connect the meter according to above diagram. After the connection completed successfully, the inverter will show the load power on the LCD. **But please don't setup "Meter ON"** . Also, you will be able to browse the load power on the monitoring platform. The plant setting method as below description.

Firstly, go to the solarman platform(<https://pro.solarmanpv.com>, this link is for solarman distributor account; or <https://home.solarmanpv.com>, this link is for solarman end user account;) plant home page and click "edit"

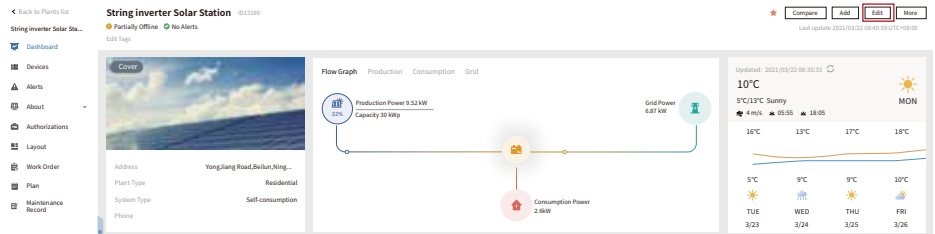

And then choose your system type as "Self-consumption"

The 'Edit Plant' form contains the following fields:

- Basic Info:** Address (Yong Jiang Road, Beijing, China)
- System Info:** Plant Type (Residential), System Type (Self-consumption), Capacity (kW) (30)
- Yield Info:** Longitude (121.46), Latitude (19.93), Time Zone (UTC+08:00 Beijing, Chongqing, Hong Kong, Urumqi), Creation Time (2020/04/08)

Secondly, go to plant page, if it shows the PV power, load power and grid power, which means the configuration is correct.

String Inverter Solar Station 013339

Partially Offline No Alerts

Compare Add Edit More

Last updated: 2021/01/22 08:55:01+08:00

Dashboard

Devices

Alerts

About

Authorizations

Layout

Work Order

Plan

Maintenance Record

Address: YongJiang Road,BaLun,Ning...

Plant Type: Residential

System Type: Self-consumption

Phone:

Flow Graph Production Consumption Grid

Production Power 9.52 kW  
Capacity 30 kWp

Grid Power 6.87 kW

Consumption Power 2.6kW

Updated: 2021/01/22 08:35:33

10°C

5°C/13°C Sunny

4 m/s 05:55 08:05

MON

16°C 13°C 17°C 18°C

5°C 9°C 9°C 10°C

TUE WED THU FRI

3/23 3/24 3/25 3/26

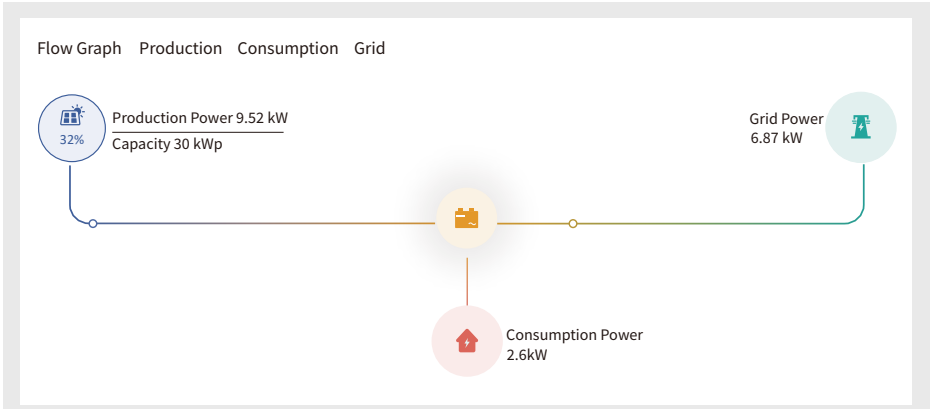

## 8. General Operation

During normal operation, the LCD shows the current status of the inverter, including the current power, total generation, a bar chart of power operation and inverter ID, etc. Press the Up key and the Down key to see the current DC voltage, DC current, AC voltage, AC current, inverter radiator temperature, software version number and Wifi connection state of the inverter.

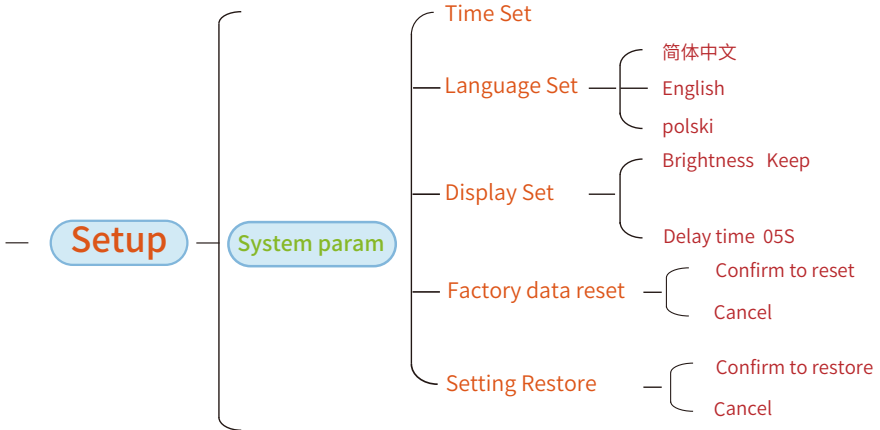
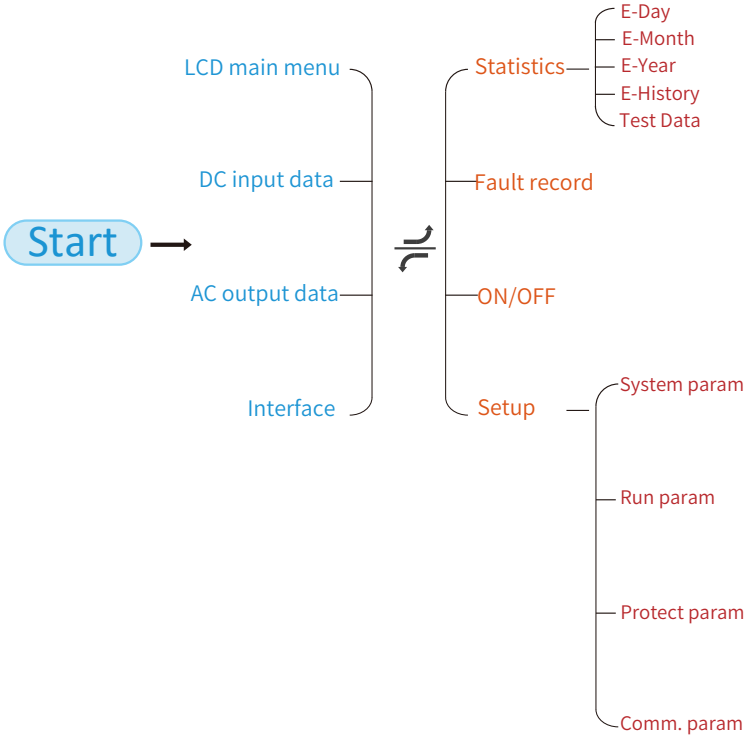

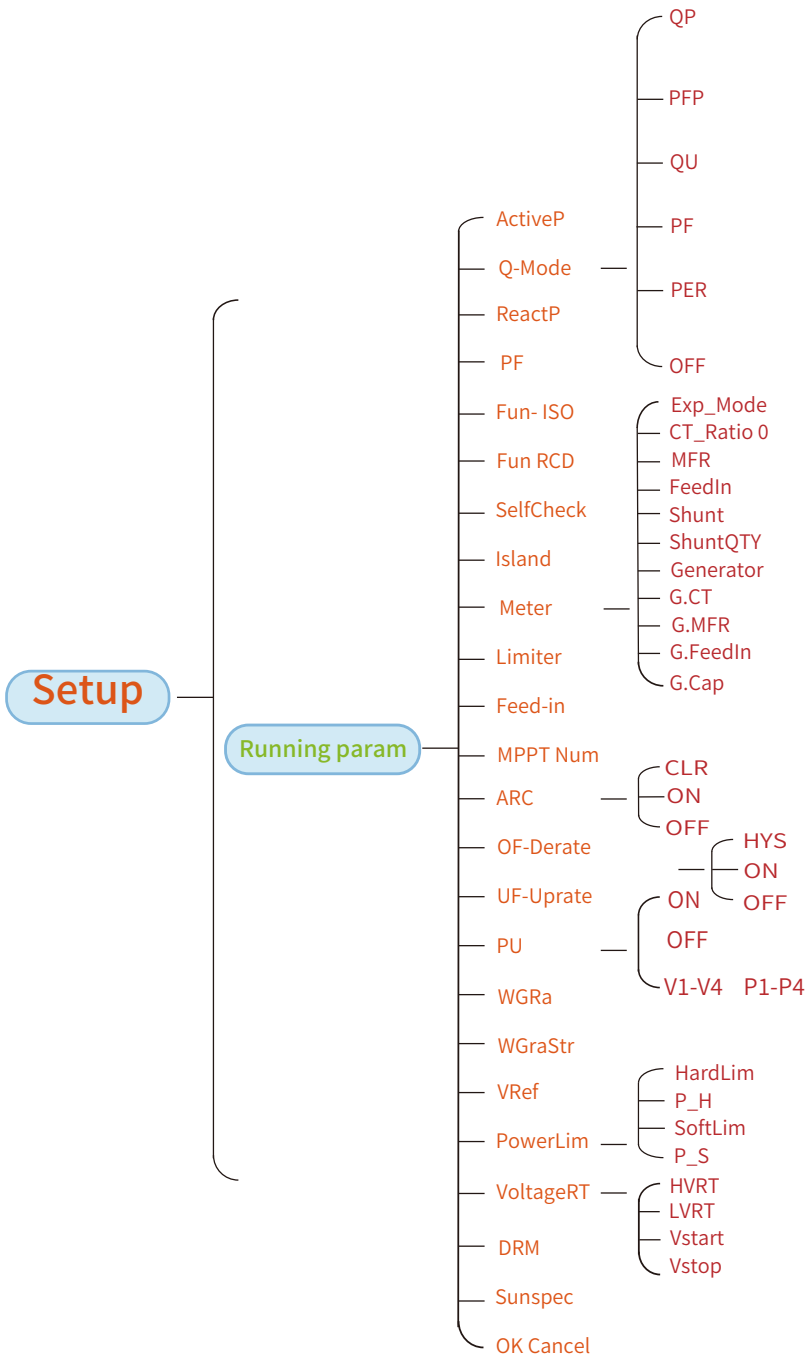

\*Note: These parameters will be available after the meter is connected successfully. Otherwise, it won't show.

Attention: For running param detail on the LCD display, please refer to the official Deye website <https://www.deyeinverter.com>

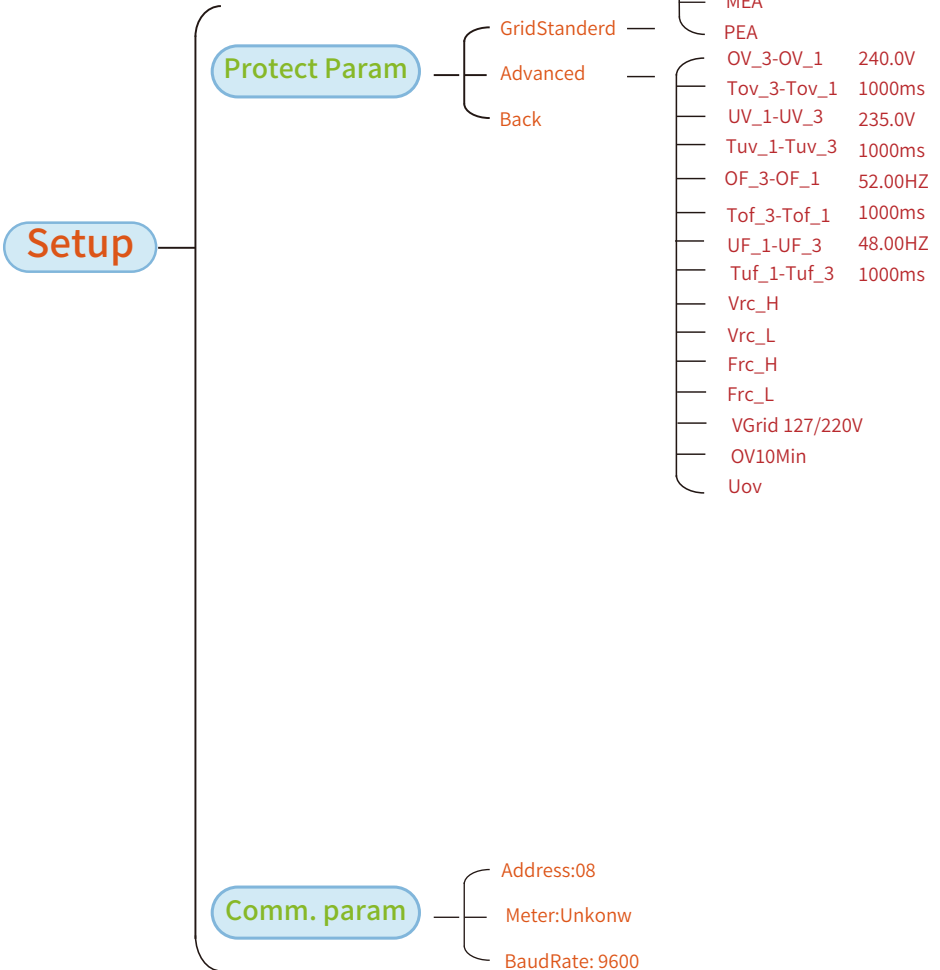

## 8.1 The initial interface

From the initial interface, you can check power, daily generation, gross generation, invertert ID , model and time.

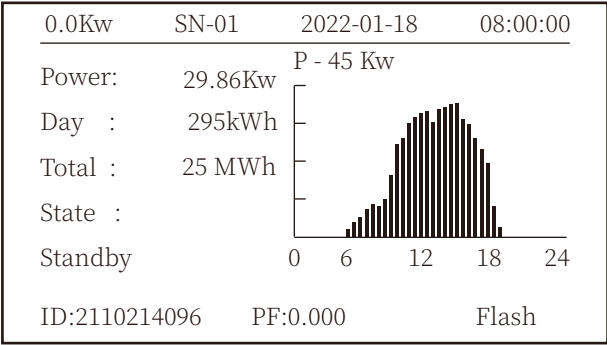

Pic 8.1 The initial interface

Press UP or Down you can check inverter DC voltage, DC current, AC voltage, AC current, inverter temperature, software version information.

RUN	Input		
PV1	V : 349.9V	I : 10.3A	P : 3.6KW
PV2	V : 313.0V	I : 8.3A	P : 2.6KW

Pic 8.2 PV input and DC current information

You can check the PV information, the number of strings input, MPPT voltage and MPPT current.

<u>RUN</u>	<u>Grid</u>
Ua : 234.5V	Ia : 0.0A
Grid Freq : 50.00Hz	
PF : 0.000	

Pic 8.3 AC running state information

You can check the three phase voltage, current, and grid frequency.

<u>RUN</u>
Total DC Power:
3.602W
Lcd0196 Inv1400
● ●

Pic 8.4 Inverter firmware version

You can check the inverter LCD software Ver0196 and Control Software Version Ver1400. There are two black spot in the bottom right corner. The first flash means inverter is communicating with LCD. The second flash means LCD is communicating with wifi plug.

<u>PARAMETR</u>	<u>Meter</u>
	SN: 0
Meter Power: 0W	
Load Power: 0W	
Day	Total
ImpEp : 0.00kWh	0.00kWh
ExpEp : 0.00kWh	0.00kWh
LoadEp : 0.00kWh	0.00kWh

Pic 8.5 Meter power and load power



### 8.1.1 Main Menu

There are four submenu in the Main Menu.

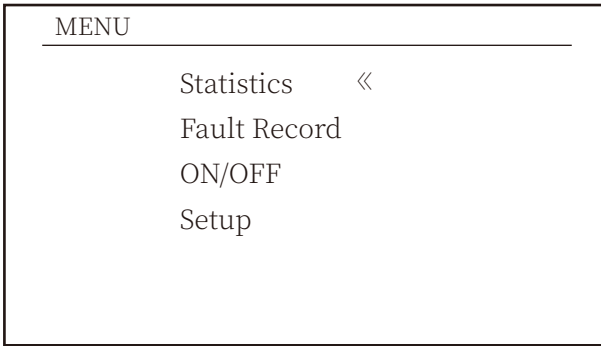

Pic 8.6 Main Menu

### 8.2 Statistics information

There are five submenu in the statistics.

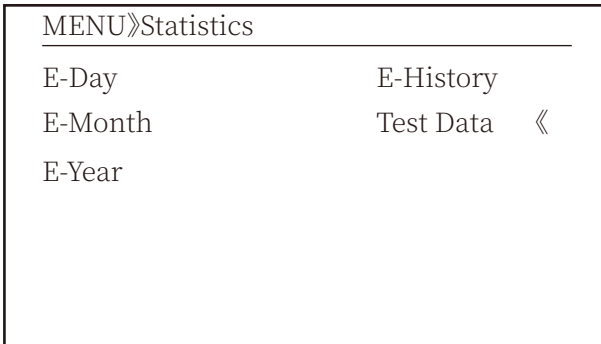

Pic 8.7 Statistics

Into each submenu through cursor.

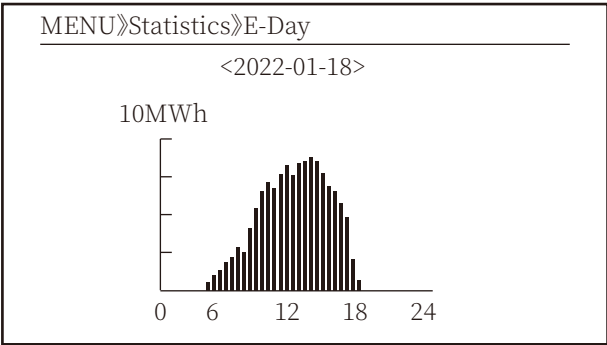

Pic 8.8 E-Day

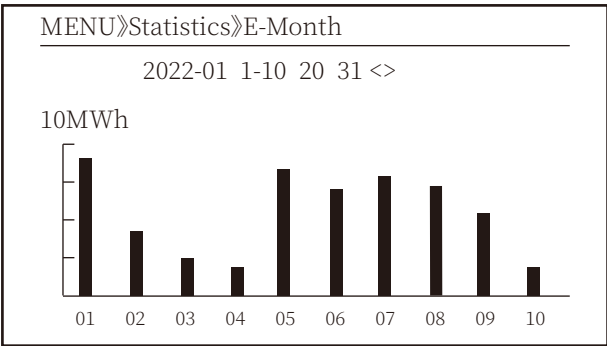

Pic 8.9 E-Month

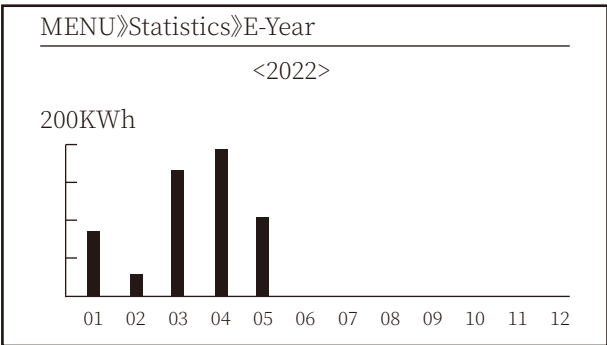

Pic 8.10 E-Year

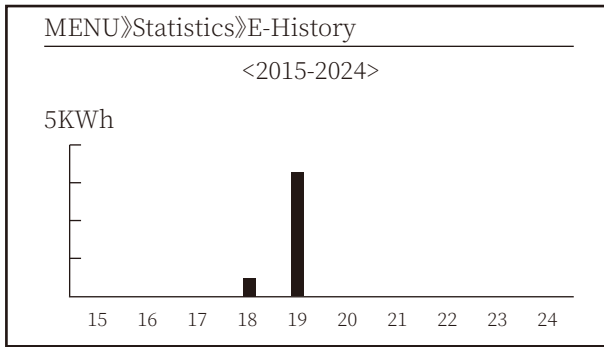

Pic 8.11 E-History

This information is for technician' s reference.

PV1 :	19186	1k3 :	11126	ofC :	2057
PV2 :	19198	1k4 :	11140	137 :	2145
HV :	24362	1k5 :	16666	138 :	2248
GFD :	9119	1k6 :	2927	139 :	1497
DiL :	36	vHV :	24362	140 :	0
AVL :	-2	BSn :	12218	141 :	0
126 :	287	ofA :	2065	142 :	0
1k2 :	6	ofB :	2653	143 :	0
146 :	0	148 :	0	144 :	0
147 :	0	149 :	0	145 :	0

Pic 8.12 Test Data

### 8.3 Fault Record

Only can keep four fault record in the menu include time, customer can deal with it depends on the error code.

MENU》Fault Record

Fault :	F352022-01-05 08:38
History : 1	F352022-01-05 08:37
2	F352022-01-04 18:47
3	F352022-01-04 17:54
4	F352022-01-04 17:53

Pic 8.13 Fault Record

## 8.4 ON/OFF setting

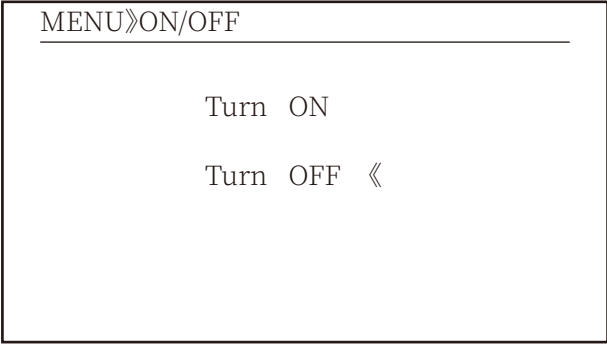

Pic 8.14 ON/OFF setting

Into each submenu through cursor.

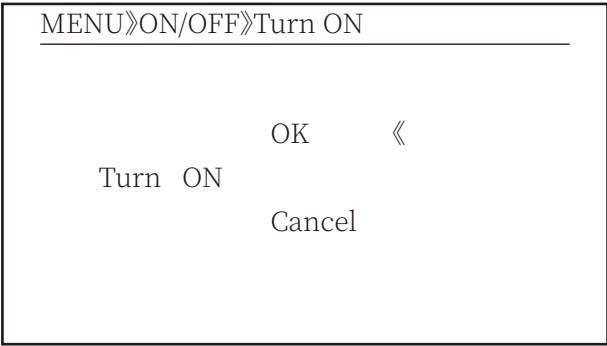

Pic 8.15 ON set

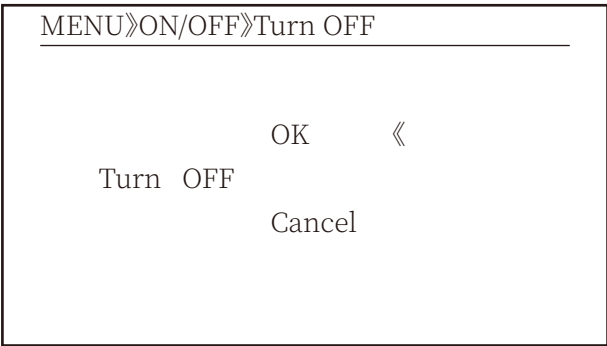

Pic 8.16 OFF set

## 8.5 Parameter setting

Setting includes system param, run param, protect param, comm.. param. All of these information for maintenance reference.

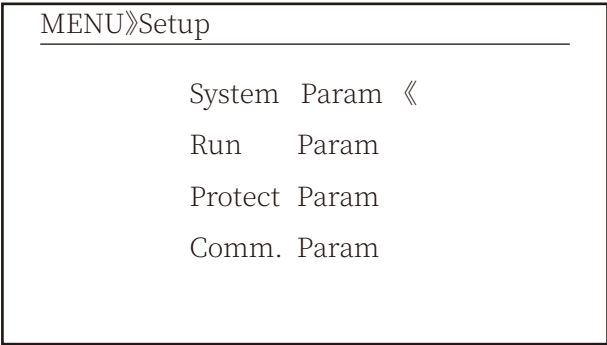

Pic 8.17 Setting

### 8.5.1 System Param

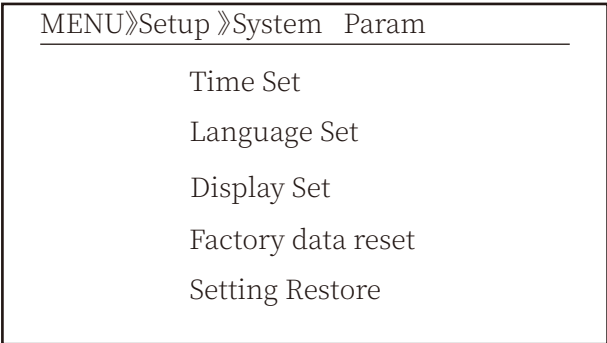

Pic 8.17.1 System Param Setting

**8.5.1.1 Time Set**

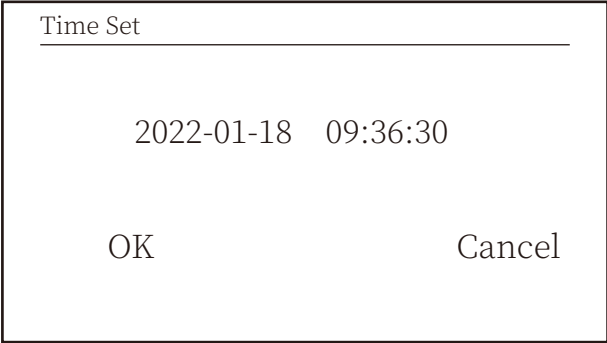

Pic 8.18 System Param

**8.5.1.2 Language Set**



Pic 8.19 Language set

**8.5.1.3 Display Set**

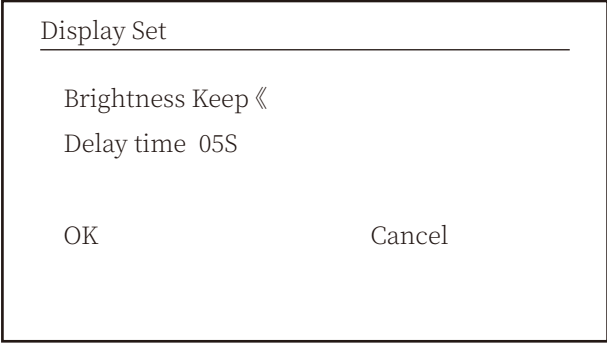

Pic 8.20 Display set

### 8.5.1.4 Factory data reset

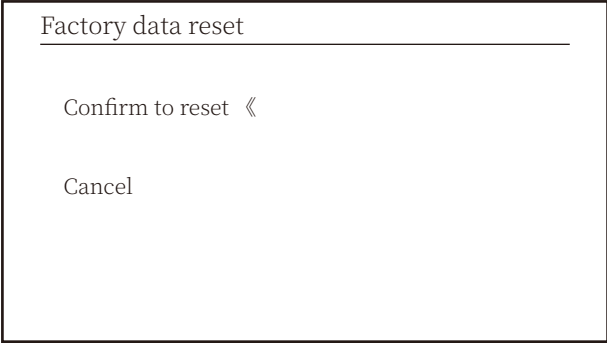

Pic 8.21 Factory data reset set

### 8.5.1.5 Setting Restore

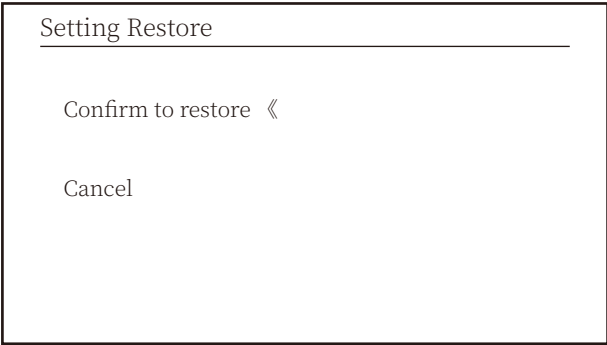

Pic 8.22 Factory data reset set



**Warning:** Password required-- only for access-authorized engineer. Un-authorized access may avoid the warranty. The initial password is 1234.

## 8.5.2 Protect Param

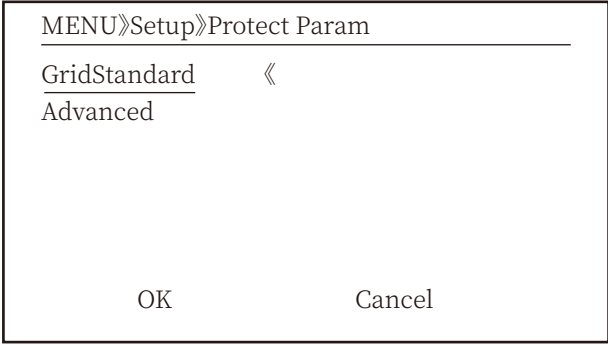

Pic 8.23 Protect Param



**Warning:**  
Engineer only.

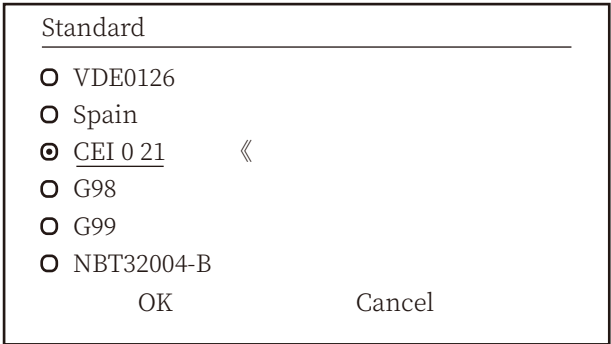
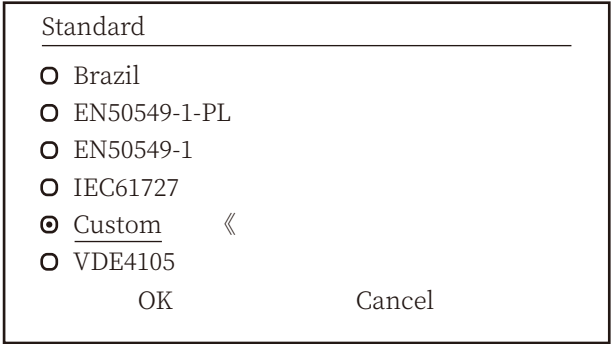



Standard

---

- Australia-A
- Australia-B
- Australia-C 《
- New Zealand
- MEA
- PEA

OK                      Cancel

Standard

---

- Norway
- Switerland
- R25 《
- CEI-016

OK                      Cancel

Pic 8.24 "Standard"

- VoltageTriping

---

OV_3	240.0V	Tov_3	1000ms
OV_2	240.0V	Tov_2	1000ms
OV_1	240.0V	Tov_1	1000ms
UV_1	240.0V	Tuv_1	1000ms
UV_2	240.0V	Tuv_2	1000ms
UV_3	240.0V	Tuv_3	1000ms

OK                      Cancel

- Frequency Tripping			
OF_3	52.00Hz	Tof_3	1000ms
OF_2	52.00Hz	Tof_2	1000ms
OF_1	52.00Hz	Tof_1	1000ms
UF_1	48.00Hz	Tuf_1	1000ms
UF_2	48.00Hz	Tuf_2	1000ms
UF_3	48.00Hz	Tuf_3	1000ms
OK		Cancel	

- Miscellaneous			
Vrc_H	0.0V	Uov	0.0%
Vrc_L	0.0V		
Frc_H	0.0Hz		
Frc_L	0.0Hz		
VGrid	127/220V		
OV10Min	OFF		
OK		Cancel	

Pic 8.25 “Advanced”

### 8.5.3 Comm. Param

MENU»Setup»Comm.Param	
WIFI-SET	485-SET
Address : 01	Address : 01
	Func : 485
	Baud : 9600

Pic 8.26 Communication param

---

## 9. Repair and Maintenance

String type inverter doesn't need regular maintenance. However, debris or dust will affect heat sink's thermal performance. It is better to clean it with a soft brush. If the surface is too dirty and affect the reading of LCD and LED lamp, you can use wet cloth to clean it up.



### High Temperature Hazard:

When the device is running, the local temperature is too high and the touch can cause burns. Turn off the inverter and wait for it cooling, then you can clean and maintain.



### Safety Hint:

No solvent, abrasive materials or corrosive materials can be used for cleaning any parts of the inverter.

## 10. Error information and processing

Inverter has been designed in accordance with international grid tied standards for safety, and electromagnetic compatibility requirements. Before delivering to the customer the inverter has been subjected to several tests to ensure its optimal operation and reliability.

### 10.1 Error code

If there is any failure, the LCD screen will display an alarm message. In this case, the inverter may stop feeding energy into the grid. The alarm description and their corresponding alarm messages are listed Table 10.1.

Error code	Description	Ongrid - Three Phase
F01	DC input polarity reverse fault	Check the PV input polarity.
F02	DC insulation impedance permanent fault	Check the grounding cable of inverter.
F03	DC leakage current fault	Hardly appear the code. Never ever happened so far.
F04	Ground fault GFDI	Check the solar panel output connection.
F05	Read the memory error	Failure in reading memory (EEPROM). Restart the inverter if the fault still exists, contact your installer or Deye service.
F06	Write the memory error	Failure in writing memory (EEPROM). Restart the inverter if the fault still exists, contact your installer or Deye service.
F07	GFDI blown fuse	Hardly appear the code. Never ever happened so far.
F08	GFDI grounding touch failure	Hardly appear the code. Never ever happened so far.
F09	IGBT damaged by excessive drop voltage	Hardly appear the code. Never ever happened so far.
F10	Auxiliary switch power supply failure	1. It tells the DC 12V is not existed. 2. Restart the inverter, if the fault still exists, please contact your installer.
F11	AC main contactor errors	Hardly appear the code. Never ever happened so far.
F12	AC auxiliary contactor errors	Hardly appear the code. Never ever happened so far.
F13	reserved	1. Loss of one phase or AC voltage detection part failure or relays not closed. 2. Restart the inverter, if the error still exists, please contact your installer or Deye service.
F14	DC firmware over current	Hardly appear the code. Never ever happened so far.
F15	AC firmware over current	1. The internal AC sensor or detection circuit on control board or connection wire may loose. 2. Restart the inverter, if the error still exists, please contact your installer or Deye service.
F16	GFCI(RCD) Ac leakage current fault	1. This fault means the average leakage current is over 300mA. Check whether DC power supply or solar panels is ok, then check 'Test data'-> 'diL' value is about 40; Then check the leakage current sensor or circuit (the following picture). Checking test data needs using big LCD. 2. Restart the inverter, if the error still exists, please contact your installer or Deye service.
F17	Three phase current, over-current fault	Hardly appear the code. Never ever happened so far.
F18	AC over current fault of hardware	1. Check AC sensor or detection circuit on control board or connection wire. 2. Restart the inverter or factory reset, if the error still exists, please contact your installer or Deye service.
F19	All hardware failure synthesis	Hardly appear the code. Never ever happened so far.
F20	DC over current fault of the hardware	1. Check whether solar panel output current is within the allowed range. 2. Check DC current sensor and its detection circuit. 3. Check if the inverter FW version is suitable for the hardware. 4. Restart the inverter, if the error still exists, please contact your installer or Deye service.

Error code	Description	Ongrid - Three Phase
F21	DC leakage flow fault	Hardly appear the code. Never ever happened so far.
F22	Crash stop (if there is a stop button)	Contact your installer for help.
F23	AC leakage current is transient over current	<ol style="list-style-type: none"> <li>1. This fault means the leakage current is above 30mA suddenly. Check whether DC power supply or solar panels is ok, then check 'Test data'-&gt; 'dil' value is about 40; Then check the leakage current sensor or circuit. Check test data needs using big LCD.</li> <li>2. Restart the inverter, if the fault still exists, contact your installer or Deye service.</li> </ol>
F24	DC insulation impedance failure	<ol style="list-style-type: none"> <li>1. Check Vpe resistance on main board or detection on control board. Check PV panels is OK. Many times this issue is the PV problem.</li> <li>2. Check whether the PV panel (aluminum frame) is grounded well and inverter is grounded well. Open the cover of inverter and then check the inside ground cable is fixed well on the shell.</li> <li>3. Check if the AC/DC cable, terminal block are shorted to ground or the insulation is damaged.</li> <li>4. Restart the inverter, if the fault still exists, contact your installer or Deye service.</li> </ol>
F25	DC feedback fault	Hardly appear the code. Never ever happened so far.
F26	The DC busbar is unbalanced	<ol style="list-style-type: none"> <li>1. Check whether the 'BUSN' cable or driver board power supply cable is loose.</li> <li>2. Restart the inverter, if the fault still exists, contact your installer or Deye service.</li> </ol>
F27	DC end insulation error	Hardly appear the code. Never ever happened so far.
F28	Inverter 1 DC high fault	Hardly appear the code. Never ever happened so far.
F29	AC load switch failure	Hardly appear the code. Never ever happened so far.
F30	AC main contactor failure	<ol style="list-style-type: none"> <li>1. Check relays and AC voltage of relays.</li> <li>2. Check relays driver circuit. Check if the software is not suitable for this inverter. (Old inverter not have relays detection function)</li> <li>3. Restart the inverter, if the fault still exists, contact your installer or Deye service.</li> </ol>
F31	Relay open circuit fault	<ol style="list-style-type: none"> <li>1. At least one Relay can't be closed. Check relays and its driver signal. (Old inverter not have relays detection function)</li> <li>2. Restart the inverter, if the fault still exists, contact your installer or Deye service.</li> </ol>
F32	Inverter 2 dc high fault	Hardly appear the code. Never ever happened so far.
F33	AC over current	Hardly appear the code. Never ever happened so far.
F34	AC current over load	Hardly appear the code. Never ever happened so far.
F35	No AC grid	<ol style="list-style-type: none"> <li>1. Check AC grid voltage. Check AC voltage detection circuit. Check if the AC connector in good condition. Check whether the AC grid is normal in voltage.</li> <li>2. Restart the inverter, if the fault still exists, contact your installer or Deye service.</li> </ol>
F36	AC grid phase error	Hardly appear the code. Never ever happened so far.
F37	AC three-phase voltage unbalance failure	Hardly appear the code. Never ever happened so far.
F38	AC three-phase current unbalance failure	Hardly appear the code. Never ever happened so far.

Error code	Description	Ongrid - Three Phase
F39	AC over current(one cycle)	1. Check AC current sensor and its circuit. 2. Restart the inverter, if the fault still exists, contact your installer or Deye service.
F40	DC over current	Hardly appear the code. Never ever happened so far.
F41	AC Line W,U over voltage	Check the AC voltage protection setting. And Check if the AC cable is too thin.Check the voltage difference between LCD and meter.
F42	AC Line W,U low voltage	Check the AC voltage protection setting. Check the voltage difference between LCD and meter. Also need to check whether AC cables are all firmly and correctly connected.
F43	AC Line V,W over voltage	Check the AC voltage protection setting.And Check if the AC cable is too thin.Check the voltage difference between LCD and meter.
F44	AC Line V,W low voltage	Check the AC voltage protection setting. Check the voltage difference between LCD and meter. Also need to check whether AC cables are all firmly and correctly connected.
F45	AC Line U,V over voltage	Check the AC voltage protection setting.And Check if the AC cable is too thin.Check the voltage difference between LCD and meter.
F46	AC Line U,V low voltage	Check the AC voltage protection setting.
F47	AC Over frequency	Check the frequency protection setting.
F48	AC lower frequency	Check the frequency protection setting.
F49	U phase grid current DC component over current	Hardly appear the code. Never ever happened so far.
F50	V phase grid current DC component over current	Hardly appear the code. Never ever happened so far.
F51	W phase grid current DC component over current	Hardly appear the code. Never ever happened so far.
F52	AC inductor A, phase current DC current high	Hardly appear the code. Never ever happened so far.
F53	AC inductor B, phase current DC current high	Hardly appear the code. Never ever happened so far.
F54	AC inductor C, phase current DC current high	Hardly appear the code. Never ever happened so far.
F55	DC busbar voltage is too high	1. Check PV voltage and Ubus voltage and its detection circuit. If the PV input voltage exceeds the limit, please reduce the number of solar panels in series. 2. For Ubus voltage, please check the LCD display.
F56	DC busbar voltage is too low	1. It tells the PV input voltage is low and it always happens in the early morning. 2. Check PV voltage and Ubus voltage. When inverter is running, then showing F56, maybe Loss of driver or need update firmware. 3. Restart the inverter, if the fault still exists, contact your installer or Deye service.
F57	AC reverse irrigation	AC reverse irrigation.
F58	AC grid U over current	Hardly appear the code. Never ever happened so far.

Error code	Description	Ongrid - Three Phase
F59	AC grid V over current	Hardly appear the code. Never ever happened so far.
F60	AC grid W over current	Hardly appear the code. Never ever happened so far.
F61	Reactor A phase over current	Hardly appear the code. Never ever happened so far.
F62	Reactor B phase over current	Hardly appear the code. Never ever happened so far.
F63	ARC fault	1. Check PV module cable connection and clear the fault; 2. Seek help from us, if can not go back to normal state.
F64	IGBT heat sink high temperature	1. Check temperature sensor. Check if firmware is suitable for the hardware. Check if the inverter is its right model. 2. Restart the inverter, if the fault still exists, contact your installer.

Table10.1 Error codes and their solutions



**Safety Hint:**

If your string inverter has any of the fault information shown in Table 10-1, and when you reset the machine and still don't solve the problem, please contact our distributor and provide the below details:

1. Serial number of the inverter;
2. The distributor/dealer of the inverter(if available);
3. Installation date;
4. The discription of problem(include LCD'error code and LED starus indicator lights);
5. Your contact details.

# 11. Specification

Model	SUN-60K-G	SUN-70K-G	SUN-75K-G	SUN-80K-G
<b>PV String Input Data</b>				
Max. PV Input Power(kW)	78	91	97.5	104
Max. PV Input Voltage(V)	1000			
Start-up Voltage(V)	250			
PV Input Voltage Range(V)	250-1000			
MPPT Voltage Range(V)	200-850			
Full Load MPPT Voltage Range(V)	550-850			
Rated PV Input Voltage(V)	600			
Max. Input Short Circuit Current (A)	60+60+60+60	60+60+60+60		
Max. Operating PV Input Current(A)	40+40+40+40	40+40+40+40		
No. of MPP Trackers/No. of Strings MPP Tracker	4/3+3+3+3	4/4+4+4+4		
Max. Inverter Backfeed Current To the Array	0			
<b>AC Output Data</b>				
Rated AC Output Active Power(kW)	60	70	75	80
Max.AC Output Apparent Power(kVA)	66	77	82.5	88
Rated AC Output current (A)	90.9/87.0	106.1/101.5	113.6/108.7	121.2/115.9
Max.AC Output Current(A)	100/95.7	116.7/111.6	125/119.6	133.3/127.5
Max. Output Fault Current (A)	174	203	217.4	231.8
Max. Output Overcurrent Protection (A)	176	208	208	208
Rated Output voltage/range (V)	220/380V 230/400V 0.85Un-1.1Un			
Grid Connection Form	3L+N+PE			
Rated Output Grid Frequency/range(Hz)	50Hz/45Hz-55Hz, 60Hz/55Hz-65Hz			
Power Factor Adjustment Range	0.8 leading-0.8lagging			
Total Current Harmonic Distortion THDi	<3%			
DC Injection Current	<0.5%In			
<b>Efficiency</b>				
Max.Efficiency	98.6%	98.7%		
Euro Efficiency	98.0%	98.1%		
MPPT Efficiency	>99%			
<b>Equipment Protection</b>				
DC Polarity Reverse Connection Protection	yes			
AC Output Overcurrent Protection	yes			
AC Output Overvoltage Protection	yes			
AC Output Short Circuit Protection	yes			
Thermal Protection	yes			
DC Terminal Insulation Impedance Monitoring	yes			
DC component monitoring	yes			
Ground fault current monitoring	yes			
Arc fault circuit interrupter(AFCI)	Optional			
Power Network Monitoring	yes			
Island protection monitoring	yes			
Earth Fault Detection	yes			
DC Input Switch	yes			
Overvoltage Load Drop Protection	yes			
Residual Current (RCD) Detection	yes			
Surge Protection Level	TYPE II(DC),TYPE II(AC)			



Interface		
Communication Interface	RS485/RS232	
Monitor Mode	GPRS/WIFI/Bluetooth/4G/LAN(optional)	
Display	LCD+LED	
General Data		
Operating Temperature Range (°C)	-25 to +65°C, >45°C derating	
Permissible Ambient Humidity	0-100%	
Permissible Altitude (m)	2000m	
Noise (dB)	≤ 50 dB	≤ 55dB
Ingress Protection(IP) Rating	IP 65	
Inverter Topology	Non-Isolated	
Over Voltage Category	OVC II(DC),OVC III(AC)	
Cabinet Size (W*H*D) [mm]	700×575×297 (Excluding connectors and brackets)	
Weight [kg]	60	
Warranty [year]	Standard 5 years, extended warranty	
Type Of Cooling	Intelligent air cooling	
Grid Regulation	IEC 61727, IEC 62116, CEI 0-21, CEI 0-16, EN 50549, NRS 097, RD 140, UNE 217002, OVE-Richtlinie R25, G99, VDE-AR-N 4105, VDE-AR-N 411	
Safety EMC/Standard	IEC/EN 61000-6-1/2/3/4, IEC/EN 62109-1, IEC/EN 62109-2	

## 12. EU Declaration of Conformity

within the scope of the EU directives

- Electromagnetic compatibility 2014/30/EU (EMC)
- Low Voltage Directive 2014/35/EU (LVD)
- Restriction of the use of certain hazardous substances 2011/65/EU(RoHS)



NINGBO DEYE INVERTER TECHNOLOGY CO., LTD. confirms herewith that the products described in this document are in compliance with the fundamental requirements and other relevant provisions of the above mentioned directives. The entire EU Declaration of Conformity and certificate can be found at <https://www.deyeinverter.com/download/#string-inverter>.

# EU Declaration of Conformity

Product: **Grid-connected PV Inverter**

Models: SUN-60K-G;SUN-70K-G;SUN-75K-G;SUN-80K-G

Name and address of the manufacturer: Ningbo Deye Inverter Technology Co., Ltd.

No. 26 South YongJiang Road, Daqi, Beilun, NingBo, China

This declaration of conformity is issued under the sole responsibility of the manufacturer. Also this product is under manufacturer's warranty.

This declaration of conformity is not valid any longer: if the product is modified, supplemented or changed in any other way, as well as in case the product is used or installed improperly.

The object of the declaration described above is in conformity with the relevant Union harmonization legislation: The Low Voltage Directive (LVD) 2014/35/EU;the Electromagnetic Compatibility (EMC) Directive 2014/30/EU;the restriction of the use of certain hazardous substances (RoHS) Directive 2011/65/EU.

References to the relevant harmonized standards used or references to the other technical specifications in relation to which conformity is declared:

<b>LVD:</b>	
EN 62109-1:2010	●
EN 62109-2:2011	●
<b>EMC:</b>	
EN 61000-6-2:2005	●
EN 61000-6-4:2007+A1:2011	●

**Nom et Titre / Name and Title:**

Bard Dai  
Senior Standard and Certification Engineer  
  
NINGBO DEYE INVERTER TECHNOLOGY CO.,LTD.

**Au nom de / On behalf of:**

Ningbo Deye Inverter Technology Co., Ltd.

**Date / Date (yyyy-mm-dd):**

2023-09-27

**A / Place:**

Ningbo, China

## NINGBO DEYE INVERTER TECHNOLOGY CO., LTD.

Add. : No.26 South YongJiang Road, Daqi, Beilun, NingBo, China.

Tel. : +86 (0) 574 8622 8957

Fax. : +86 (0) 574 8622 8852

E-mail. : [service@deye.com.cn](mailto:service@deye.com.cn)

Web. : [www.deyeinverter.com](http://www.deyeinverter.com)



30240301002734